



INTERCOM SYSTEM

---

# TOA EXES-5000 INTERCOM SYSTEM

---

## INSTALLATION HAND BOOK & TROUBLE SHOOTING



**TOA ELECTRIC CO., LTD.**

KOBE, JAPAN

# CONTENTS

	Page
1. Introduction .....	2
2. Introduction of the EXES-5000 System .....	3
2-1. Exchange .....	3
2-1-1. Features	
2-1-2. Specifications	
2-1-3. Further Details	
2-2. Stations .....	19
2-2-1. Features	
2-2-2. Specifications	
2-3. Accessories .....	21
2-3-1. Terminal Board BOX-064	
2-3-2. Junction Cable YR-801	
3. Installation of the EXES-5000 System .....	23
3-1. Exchange .....	23
3-2. Stations .....	24
3-3. Accessories .....	25
4. Cable Installation and Connection .....	26
4-1. Cable Installation .....	26
4-2. Core Diameter VS Transmission Distance .....	28
4-3. Wiring .....	29
4-4. Piping .....	30
4-5. Exchange and Terminal Board Connection .....	32
4-6. Connection of the Station Plug to the Exchange Jack .....	39
4-7. Zone/Group Paging Connection .....	40
4-8. Connection of Power Supply .....	46
5. Programming of Secretary transfer, Master/Sub-station and/or "Executive Priority" functions .....	48
6. Adjustment of the CPU module .....	54
7. Inspection .....	58
7-1. Inspection before Power on .....	58
7-2. Testing .....	59
8. Trouble-shooting Guide .....	60

# CONTENTS

8.	Trouble Shooting Guide .....	60
8-1.	Fault in Exchange .....	62
8-2.	How to Find Short between T-Line and R-Line ....	63
8-3.	Fault in Specific Station only .....	66
8-4.	Speech and Function Test .....	68

## 1. Introduction

This is the installation manual for the exchange, stations, and other components of TOA Intercom System EXES-5000.

It includes an outline of the system, an explanation of installation, cable connection, and inspection procedures, and a trouble-shooting guide. Careful study of this manual is recommended prior to installation of the system.

This manual is only intended to give the information necessary for proper installation of the system.

Prior to installation of the system, unpack the components of the system to make sure that they are in order.

## 2. Introduction of the EXES-5000 System

Because the EXES-5000 System is a fully electronic intercom system, it has the following features that surpass conventional mechanical systems.

1. All components of the exchange are designed according to the modular concept. This results in a sizable reduction in the number of procedures required to install the system.
2. The exchange and terminal board (BOX-064) are designed as separate units, allowing independent inspection of the wiring and the exchange proper.
3. The wiring for each station is an independent 4-wire system which uses a minimum number of connecting wires and means greater ease in wiring.

### 2-1. Exchange

#### 2-1-1. Feature

The features of the exchange of the TOA EXES-5000 Intercom System are as follows:

1. All components of the exchange are designed as plug-in modules. This results in a great increase in ease and speed of system installation.
2. Extensive incorporation of ICs in the electronic circuits of the exchange results in a highly compact, space-saving design and quieter operation than conventional intercom system.

This, in turn, means greater freedom in selection of installation site.

3. Since the system is completely electronic, power consumption is kept to a minimum, and incorporation of a built-in batteries is also possible.

#### 2-1-2. Specifications

The exchange of the system is available in the following two models.

EX-510 Capacity : 64 lines max. (56 lines  
with paging function).  
12 links max. (10 links  
with conference function).  
Dimensions: 20.6" (H) x 19.7" (W) x 12.6" (D)  
(522mm) (500mm) (320mm)  
Weight : 99.2 Lbs max. (45 kg. max.)

EX-520 Capacity : 128 lines max. (120 lines  
with paging function).  
16 links-max. (14 links  
with conference function).  
Dimensions: 29.3" (H) x 19.7" (W) x 12.6" (D)  
(744mm) (500mm) (320mm)  
Weight : 114.6 Lbs max. (52 kg. max.)

Exchange capacity can be increased within the given limits in units of 8 lines or 4 links. The number of links available, however, is reduced by two when the optional conference

function is incorporated. The number of lines available, on the other hand, is reduced by 8 when the paging function is adopted.

### Exchange Specifications

Ambient Temperature Range

: 32°~122°F. ( 0°~50°C.)

Audio Input Level: +10dBm (10mW)max.

Audio Output Level

: +30dBm (1W) max.

Bandwidth : 50 - 5,000Hz

Noise Level : -75dBm

Cross talk : -60dB

Harmonic Leakage : Under -40dB (circuit terminals)

Subscriber Impedance

: 600 ohms balance (input/output)

Power Consumption: EX-510 EX-520

Maximum 130W 180W

Power Source : Emergency power supply (battery pack); works approximately 2 hours during a power failure.

Regular Power Source

: AC: 120V  $\pm$  10%, 50/60HZ  
(Possible 110, 220, and 240)

Batteries : Nickel-Cadium Batteries  
(3.5AH x 2).

2-1-3. Further Details

The component modules of the exchange are grouped according to function as follows:

Common Control Section

CPU (Central Processing Unit)

OCU (Output Control Unit)

HCU (Highway Control Unit)

Speech Path Section

SGD (Signal Generating and Distributing Unit)

DLU (Duplex Link Unit)

CLU (Conference Link Unit)

LMU (Line Modem Unit)

PIU (Paging Interface Unit)

The individual units will be described later in detail. The exchange also includes the power supply unit (DS-510) and case.

The power supply unit is self-contained and can be removed from the exchange cabinet.

The exchange usually operates on AC power.

The optional battery takes over automatically



in the event of a power failure. The case is composed of a cabinet and a frame with connectors.

The cabinet is not needed when the exchange is mounted on a 19" rack.

The connectors and the frame are completely wired at the factory.

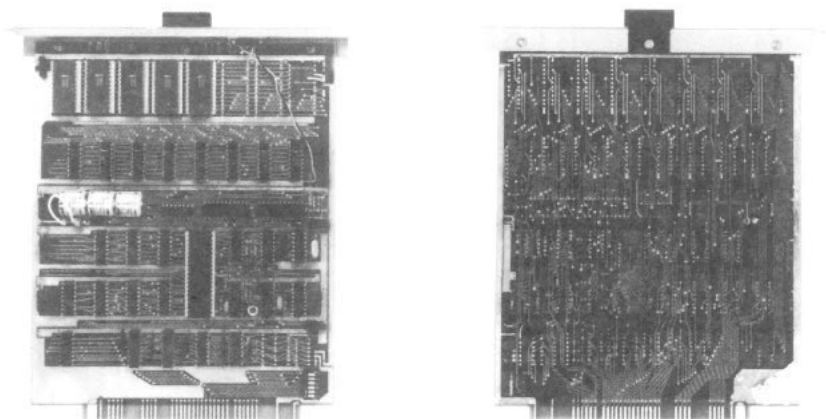

CPU (Central Processing Unit)

Function: Reads out the exchange procedure written into the memory and collates the data from the stations for processing in succession.



PROGRAM Switch

When functions such as secretary transfer, master/substation and executive priority are employed, the registration, cancellation and changing of these functions are taken care of through Station No.200. The PROGRAM switch is for converting Station No.200 to Programming station for such functions. Normally, this Switch should be kept in the OFF position.

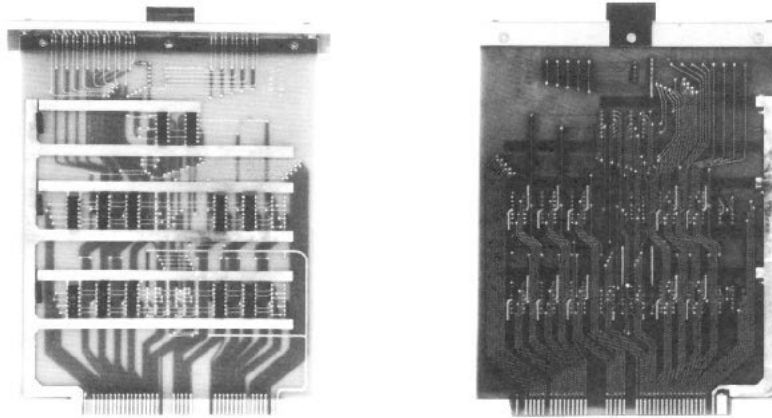

OCU (Output Control Unit)

Function: temporary storage before usage of the output data from CPU classified by lines.

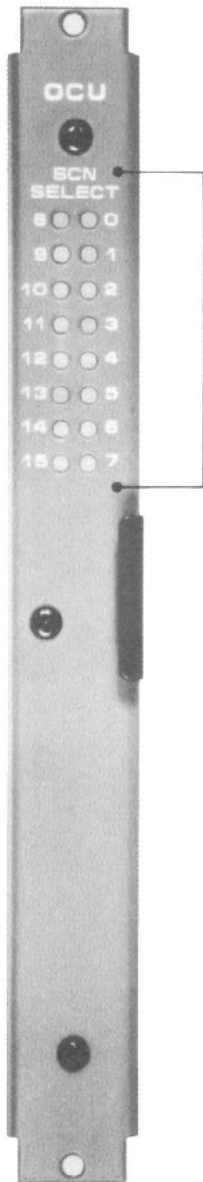

SCN SELECT Lamp

These lamps display the scanning conditions of both the station "Privacy ON/OFF" conditions and the dial data from the station in each LMU.

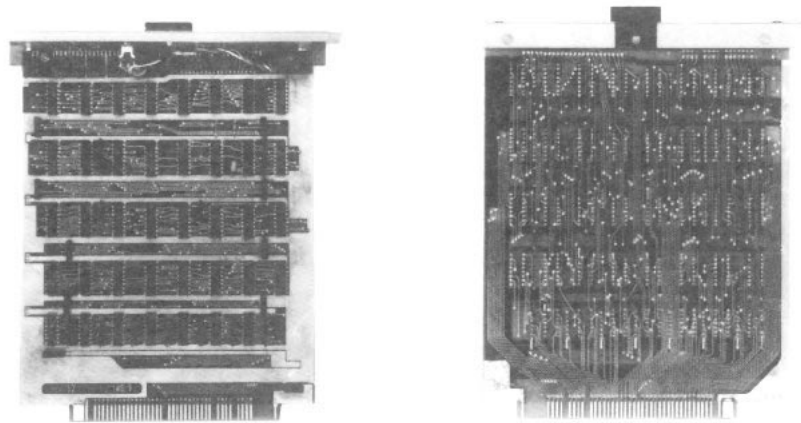

HCU (HIGHWAY CONTROL UNIT)

Function: For turning on and off the time-sharing switches at LMU, DLU and SGD according to instructions received from the CPU.



LINE ADDRESS Lamp

These lamps display the numbers of the stations using the selected link (T: Transmitting station, R: Receiving station)

SIGNAL CODE Lamp

These lamps display the code of signal tone being used by the selected link.

SIGNAL CODE				TONE
F	4	2	1	
●	○	○	○	0 Calling
●	○	○	●	1 Privacy/Disconnected
●	○	●	○	2 Busy
●	○	●	●	3 Dialing/No-registration
●	●	○	○	4 Group paging/Zone paging
●	●	○	●	5 All call
●	●	●	○	6 Priority/Executive priority
●	●	●	●	7 Registration/Call holding/Mic-off



LINK SELECT Switch

The switch position is to be selected in accordance with the number of links in use. The line address and the signal code of the link in use are then displayed by the lamps.

Note: These select switches are to be manipulated using the binary notation.

LINK BUSY Lamp

These lamps display the number of the link in use.

CLOCK Lamp

Indicates that the control signal for the time sharing switch is being transmitted normally.

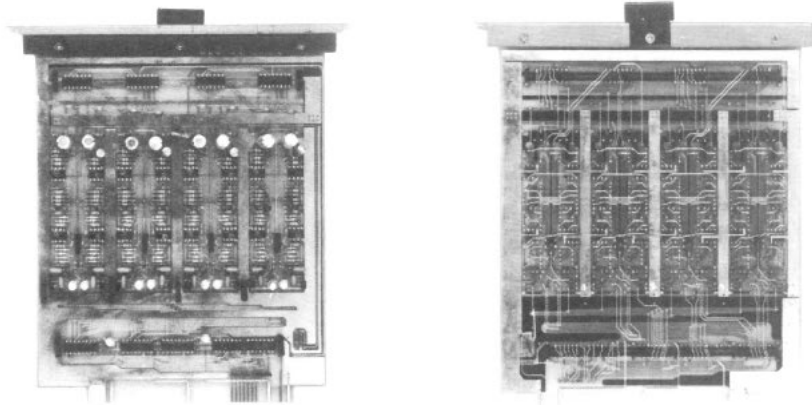

DLU (DUPLEX LINK UNIT)

Function: This unit operates under HCU control to connect or disconnect the individual links for hands free conversation between two stations. One DLU is provided with 4 links. Up to 3 DLUs can be installed with the EX-510, and up to 4 DLUs with the EX-520.



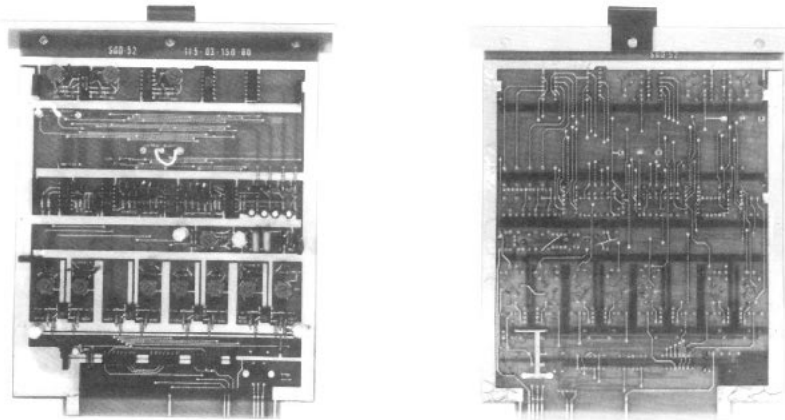

SGD (SIGNAL GENERATING AND DISTRIBUTING UNIT)

Function: Composed of 8 kinds of signal generators (calling, privacy/disconnected, busy dialing/no-registration, group paging/zone paging, all call, priority/execution priority, registration/call holding/mic-off) and distributors.

This unit distributes under HCU control the required signal tones to the individual links.

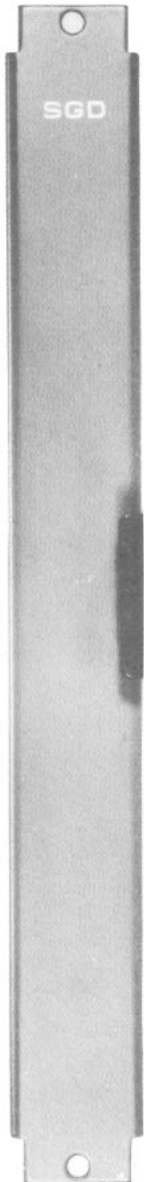

SGD-52 SIGNAL TIMING DIAGRAM

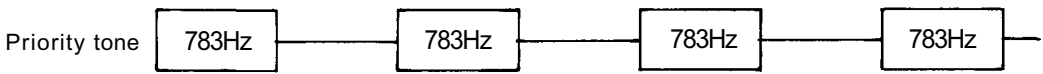
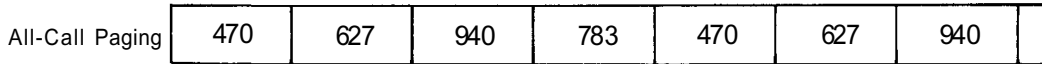
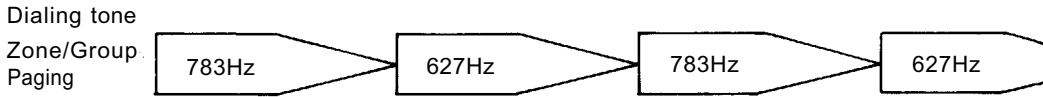
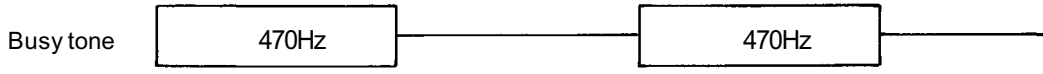
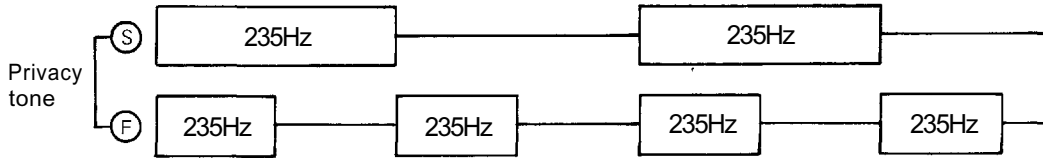
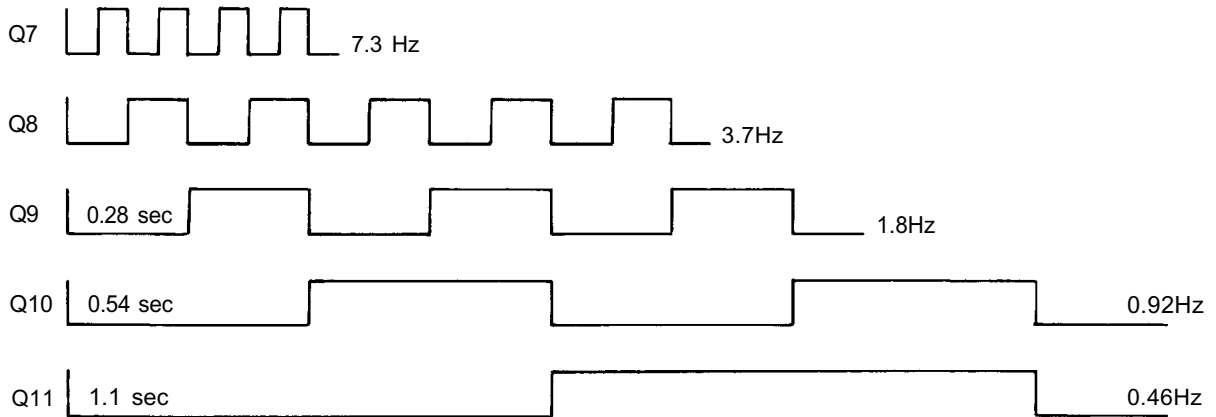



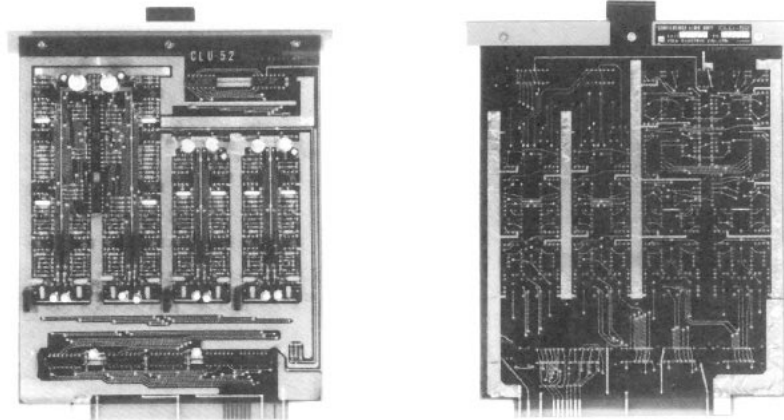

CLU (CONFERENCE LINK UNIT)

Function: This unit operates under HCU control to connect or disconnect the links for hands-free conference among up to 4 parties and hands-free speech between two parties.

One CLU is provided with 1 conference link and 2 hands-free speech links.

The CLU is optionally available.

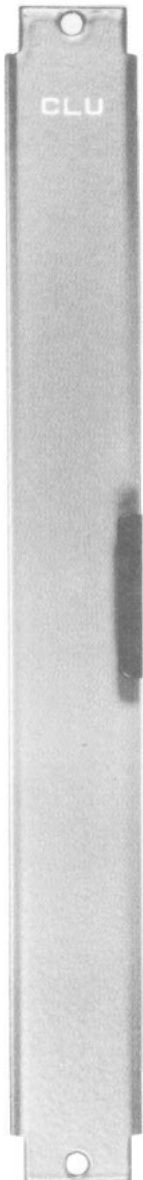

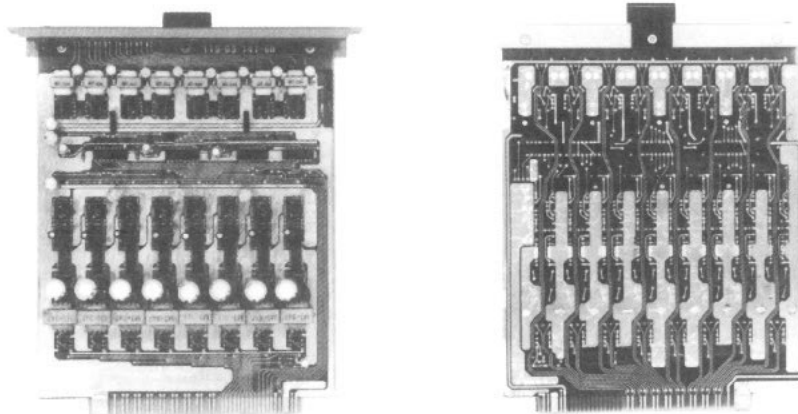

LMU (LINE MODEM UNIT)

This unit is composed of a modulator to receive signals from the station, a demodulator to send out signals to the station and a scanning circuit that scans the station "Privacy ON/OFF" conditions and the dial data.

Up to 8 stations can be connected to 1 LMU.

Station No. Lamp

Of the numbered lamps, the one corresponding to a given station is lit brightly or dimly to reflect the condition of the station.

Bright : Exchange and station are connected and the privacy switch is off.

(It is not known whether the station is busy or not)

Dim : Exchange and station are connected, with the privacy switch on.

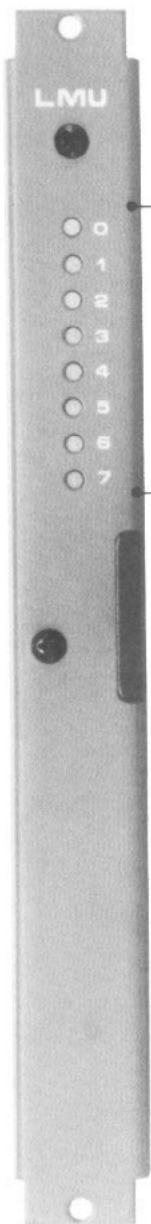

Off : Exchange and station are not connected.

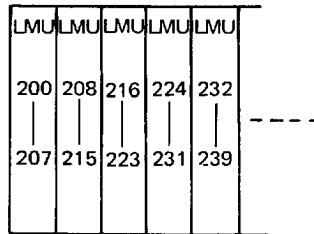

Arrangement of the LMUs with individual ranges for the station numbers covered (from left to right) is shown here.

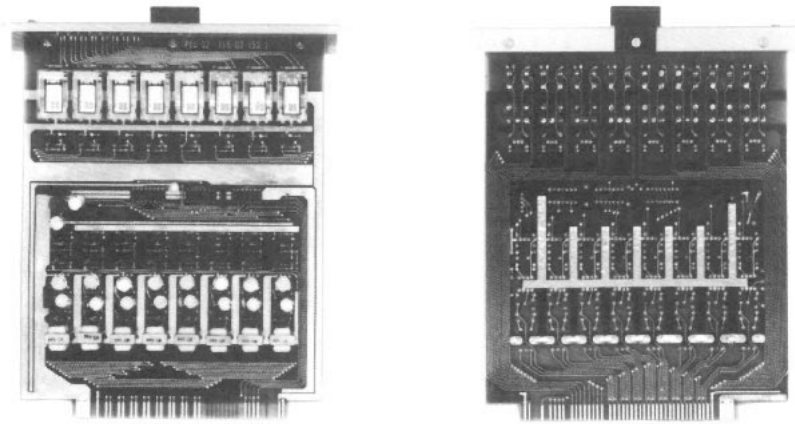

PIU (PAGING INTERFACE UNIT)

Function: This unit is provided for zone paging and group paging. It is designed to send out over the lines both zone and group paging signals. The zone paging signal goes out through the assigned YR-801 cable to terminal J8 or J16 of the Terminal board (BOX-064), while the group paging signal is distributed to the connector of the PIU unit.

This unit can control up to 7 areas (zones and/or groups) plus All-Call.

All-Call and Individual (Zone/Group) Paging Lamp

These lamps display the areas being paged as well as All-Call paging conditions. All-Call paging is displayed when all of the lamps are lit.

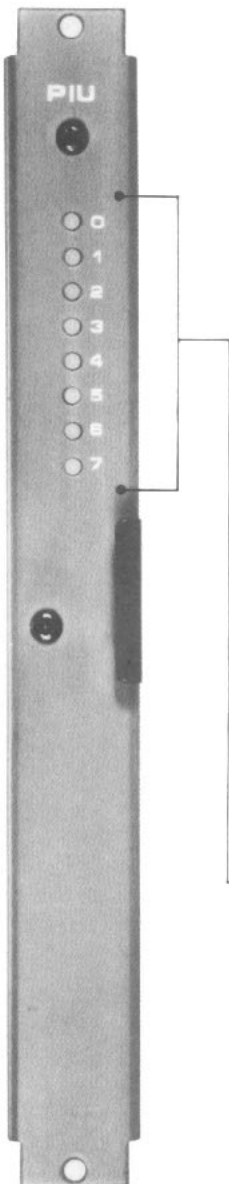

## 2-2. Stations

### 2-2-1. Features

The stations of the Toa Intercom EXES-5000 have the following features:

1. Each station is provided with a 4-Pin plug (YC-102) for easy connection to cables.
2. Wiring from the exchange to each station is the independent 4-wire system. The fact that only 4 wires are necessary makes installation easier, and with a 4-Pin jack (YC-101 or YC-103) at the end of each cable, connection can be quickly made with a screwdriver.
3. There are three types of stations available: the desk-top type, the flush mounting type and desk/wall type. Each type is available in 2 models, both master and substation, and these can be chosen in accordance with requirements.

### 2-2-2. Specifications

Stations are available in the following three models.

Model / Type / Function	Desk Type with Handset	Flush mount Type with Handset	Desk/Wall Type without Handset
Master Station	HFM-500	HFM-510	HFM-100
Sub-Station	HFS-500	HFS-510	HFS-100

Optional accessory: YC-100 Wall mounting Panel for HFM-100 and HFS-100.

YC-510 Back Box for HFM-510 and HFS-510.

Master Station: Capable of calling any master/sub-station in the system, and also of using all available functions.

Sub-Station : Capable of calling only its Master Station, and also of using the privacy, single digit dialing and press-to-talk functions.

#### Station Specifications

Ambient Temperature

: +32°~+140°F. (0°~+60°C.)

Permissible Loop Resistance

: 300 ohms

Input/Output Impedance

: 600 ohms (balanced)

Loudspeaker Output

: 300mW maximum

Handset Speaker Output

: 100mW maximum

## 2-3. Accessories

### 2-3-1. Terminal Board BOX-064

The terminal board BOX-064 provided with the Toa Intercom System EXES-5000 connects the exchange with the station lines

Compact and easy to connect, this terminal board saves space and ensures simple disconnection of any station line from the exchange when inspection is necessary. One terminal board BOX-064 can connect the 64 stations to the exchange. Two terminal board BOX-064s are needed for one exchange EX-520. The exchange and the terminal board are connected by junction cable YR-801.

To connect the station line to the terminal board, clip terminals are provided to ensure simple connection without soldering using the hardware provided. To facilitate future expansion of the system with additional stations, or modification of the system using different types of stations, it is advisable to equip the exchange with the collective terminal board to be described later on. (See page 27, Fig.9) This terminal is to be regarded as part of the exchange.

2-3-2. Junction Cable YR-801

Toa Intercom System EXES-5000 Junction Cable YR-801 connects the exchange to the terminal BOX-064. A single line of this junction cable provides sufficient wires to connect the exchange to 8 stations ( $8 \times 4 = 32$ ) through the terminal board BOX-064. At each end, the cable is equipped with a multi-pole connector which can easily be plugged into the provided socket on the exchange or the terminal board BOX-064. Refer to the drawing which appears in the Cable Installation and Connection section of this manual for the right direction and order of cable connections.



### 3. Installation of the EXES-5000 System

#### 3-1. Exchange

Pay particular attention to the following points during installation of the exchange:

- \* The layout should allow easy servicing and inspection.
- \* The exchange is compact and lightweight; however it is important to ascertain the strength of the floor or wall on which it will be placed.
- \* The exchange should be grounded. When it is used in combination with other systems, for example, a PA system, the exchange should be connected to the other components for common grounding.
- \* Choose a low "source noise" AC power supply for the exchange. Line noise can affect speech quality.
- \* Be sure to provide a power outlet for the exchange and have its capacity checked. A capacity of 500 watts should be sufficient.
- \* Plan the layout so that the terminal board BOX-064 can be installed near the exchange.
- \* The exchange can be mounted on a 19" rack.

This high performance exchange is compact as well as quiet, and can be easily installed almost anywhere. Areas described below, however, should be strictly avoided.

- \* An area where it will obstruct traffic, for example, an indoor hallway or near the entrance or exit of a room.
- \* An area where it will be exposed to fire, heat or direct sunlight (suitable ambient temperature is 32°~+122°F., 0°~+50°C.).
- \* A dusty area (where there is metal dust or dirt).
- \* Near a storage place for chemicals, oil, etc.
- \* An area subject to vibration.
- \* Near high-voltage equipment.
- \* In a strong electric field.
- \* Near equipment vulnerable to the influence of an electric field.

### 3-2. Stations

Particular attention should be given to the following points during installation.

- \* Choose a desk-type, flush mounting type or desk/wall type station according to the user's need.
- \* If the zone paging function is adopted, precautions should be taken to ensure against feed-back due to interference between the station (microphone) and the paging speaker; that is, they should be installed facing different directions or separated from each other as far as possible.
- \* The "para-branching" operation or the connection of more than one station to one circuit is not

possible.

Stations are compact for easy installation almost anywhere. However, areas described below should be strictly avoided.

- \* An area where it can be exposed to fire, heat or direct sunlight (suitable ambient temperature is 32°~+140°F., 0°~+60°C.).
- \* A dusty area (where there is metal dust or dirt).
- \* Near a storage place for chemicals, oil, etc.
- \* An area subject to vibration.
- \* Near high-voltage equipment.
- \* In a strong electric field.
- \* SCR type light dimmers.

### 3-3. Accessories

The terminal board BOX-064, which is to be connected to the exchange by junction cable YR-801, can be mounted on a wall near the exchange if the cable length (8.2 feet) and cable routing is adequate. The exchange should also be installed so that it can easily be connected to the station line.

Junction cable YR-801, which connects the exchange and the terminal board, should not be bent at a sharp angle. The terminal board should be installed so that the cable can be connected with a reasonable amount of slack in it.

#### 4. Cable Installation and Connection

##### 4-1. Cable Installation

4-1-1. Wire type, number of wire pairs and number of individual wires are to be determined for individual sections of the wiring system according to the guidelines set down below.

- \* 4-wire telephone cables unshielded 2 twisted pair cables are to be used for wiring between stations and the intermediate or indoor boards.
- \* As a rule, private branch cables are to be for wiring between indoor terminal boards, intermediate terminal boards, main terminal boards, etc.
- \* Indoors, the number of cables that can be run through a conduit is, as a rule, less than 200 pairs.
- \* Outdoor wires should be used where wiring passes through inaccessible areas such as in ceilings or under floors. Indoor wires may also be used, however, in cases where there is no risk of deterioration due to exposure to heat, etc.
- \* The number of cable pairs laid should be determined considering the possibility of future expansion of the system.

The following chart is provided to give an actual example of the wiring plan within an installed system.

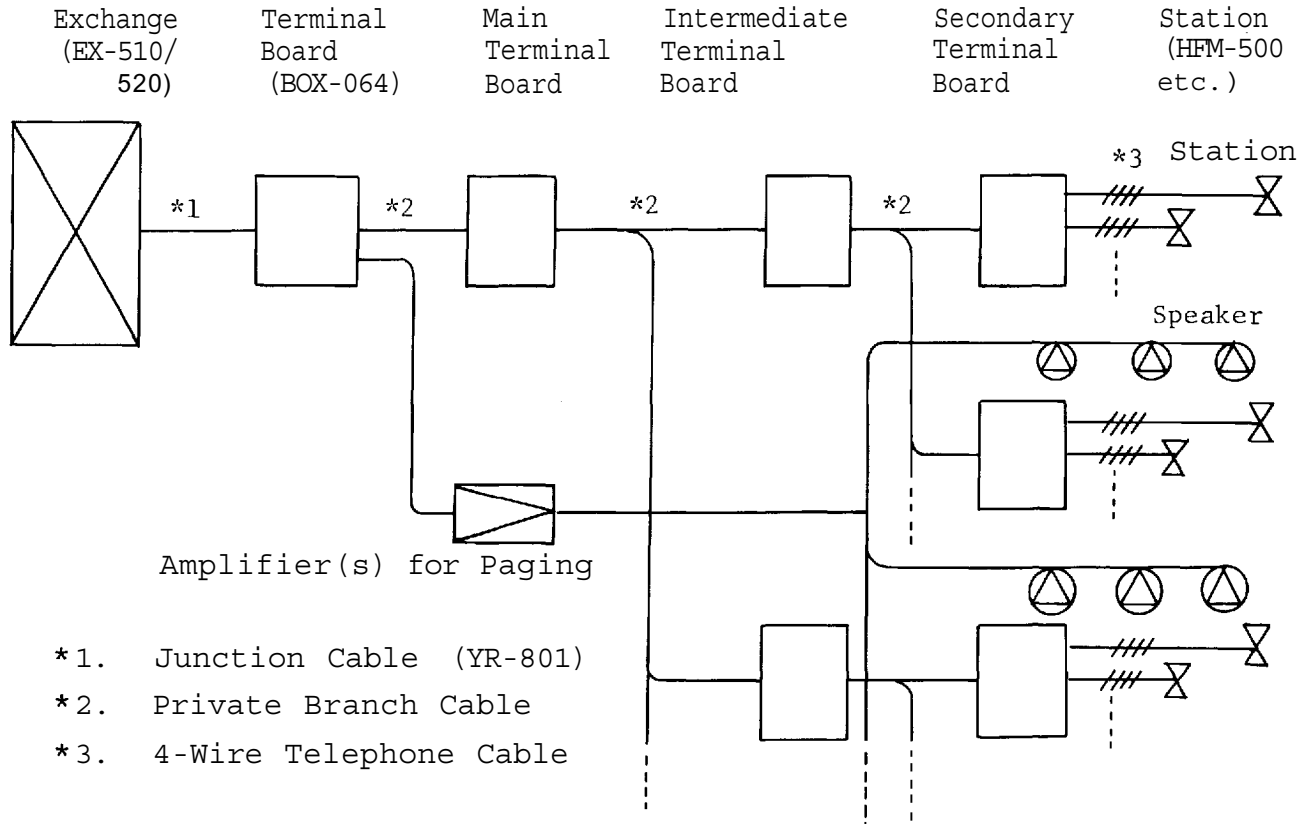

Fig. 9

Note: Since hardware to connect the cable to the terminal board BOX-064 is provided, there is a limit to the diameter of cables that can be used to connect the terminal board BOX-064 and the main terminal board, and this limit must be taken into consideration when planning wiring of the system. The diameter must be between 0.016" (0.41mm) and 0.031" (0.79mm) .

4-2. Core Diameter versus Transmission Distance

The diameter of the cable to be used should be determined so that the set limits for speech attenuation (3dB maximum for transmission from the exchange to the station) and the DC resistance (DC loop resistance: Less than 300 ohms) are met.

Speech Attenuation, DC Loop Resistance and Service Distance as Functions of Core Diameter

AWG No. (Solid)	Core Diameter mils, (mm)	Speech Attenuation db per 1000ft (dB per 1 km)	DC Loop Resistance $\Omega$ per 1000ft ( $\Omega$ per 1 km)	Service Distance ft (km)
22	25.3 (0.64)	0.411 (1.35)	35.1 (115)	7,300 (2.2)
24	20.1 (0.51)	0.521 (1.71)	54.5 (179)	5,500 (1.1)

#### 4-3. Wiring

##### General Information

- \* Wiring should be done independent of public telephone lines.
- \* Wiring conduit is often installed underground or embedded in building structures such as walls and floors, so care must be taken to draw up a wiring plan that has ample reserve for future extension of the system and that can be adapted to future remodelling or expansion of the building it is housed in. Wiring or expansion of the building it is housed in. Wiring systems must be planned with ample wires and conduit and with provision for additions to the system.

##### Spacing

Since the working voltage of this system is low and the current passing through it is small, there is no major safety problem involved in the wiring.

However, since interference due to contact with other indoor wiring can cause wire damage, leakage, and other problems, spacing should be given close consideration when the small-current wiring of this system is laid close to other indoor wiring, particularly AC wiring.

The following chart lists spacing standards to be followed in respect to typical causes of interference.

Cause of Interference	Minimum spacing acceptable without extra protection	Remarks
Heating Pipe	6" (15)	This minimum spacing requirement should be observed, since intercom cable is vulnerable to heat.
Water Pipe	4" (10)	
Radio transmitting coaxial cables (CB and other). Telephone wire.	12" (30)	More spacing is required where there is a risk of induction.
Radio/TV Antenna coaxial cables & twin lead. Ground cable.		
Protected Heating and Cooling Pipes.	4" (10)	

#### 4-4. Piping

\* Where wiring is to be passed through a wall or the like, it should be protected by a hard PVC or metal tube.



- \* If the number of connecting wires between an indoor terminal board and a station is small and the station's site is fixed so that it will not be moved frequently, install a box at that site and pull wiring through a metal or hard PVC tube as required by job or ordinance.
- \* Use a floor duct if the number of connecting wires is large and the stations are likely to be moved frequently.
- \* Station wiring which must be laid-across open areas of floor should be protected by plastic or metal shields. (See drawing below)

EXAMPLE:

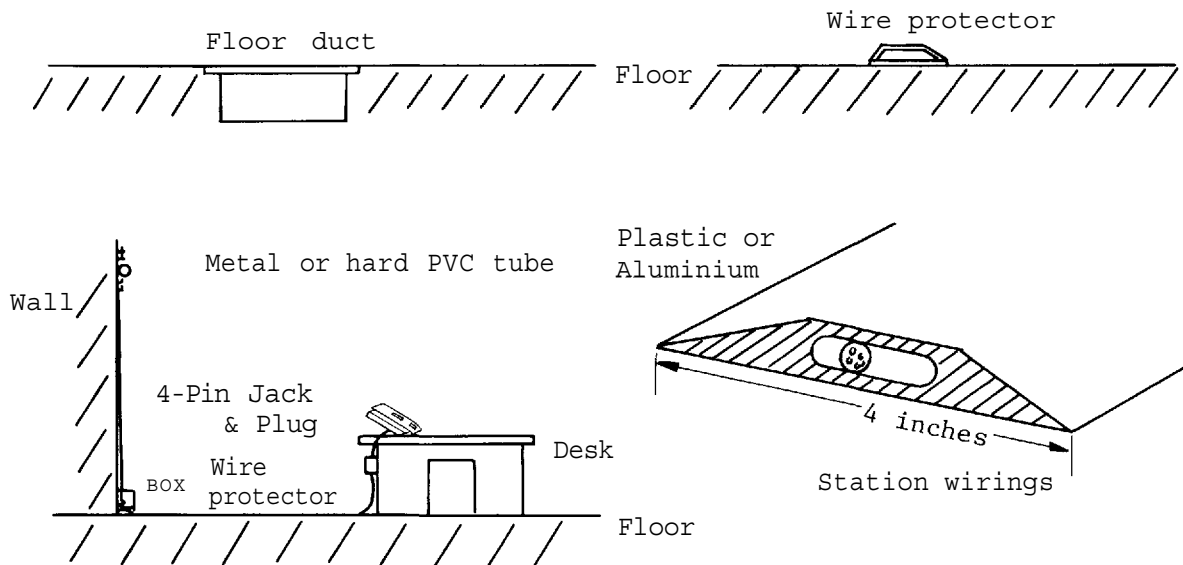

Fig. 10

#### 4-5. Exchange and Terminal Board (BOX-064) Connection

The EXES-5000 system includes terminal board BOX-064, which is connected to the exchange by junction cable YR-801.

As seen from the Fig. 11, the numbering plan begins with J1, the connector on the back of the exchange. A single junction cable should be connected to the terminal board to cover 8 station lines,

One terminal board BOX-064 can accommodate up to 64 stations, thus 128 stations can be provided with two terminal boards. If the paging function is required, however, J8 (EX-510) or J16 (EX-520) is used for paging.

Junction cable have connectors attached to each end. Be careful to make the connectors properly, otherwise damage to the connectors may occur. (See Fig.13)

Cable Diagram when Exchange EX-510 is used:  
 Exchange EX-510 with the rear panel removed.

Terminal Board (BOX-064)  
 with the cover removed.

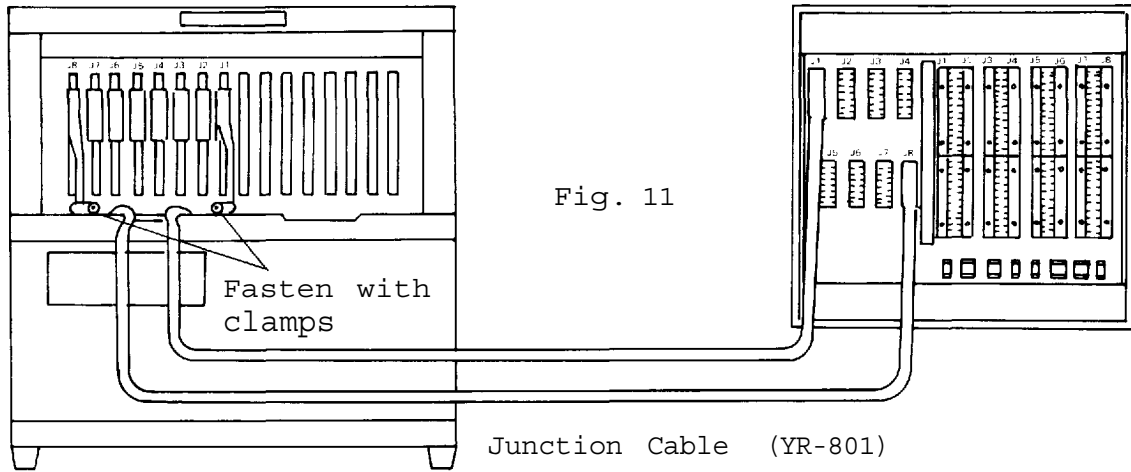

Cable Diagram when Exchange EX-520 is used:

Exchange EX-520 with  
 the rear panel removed.

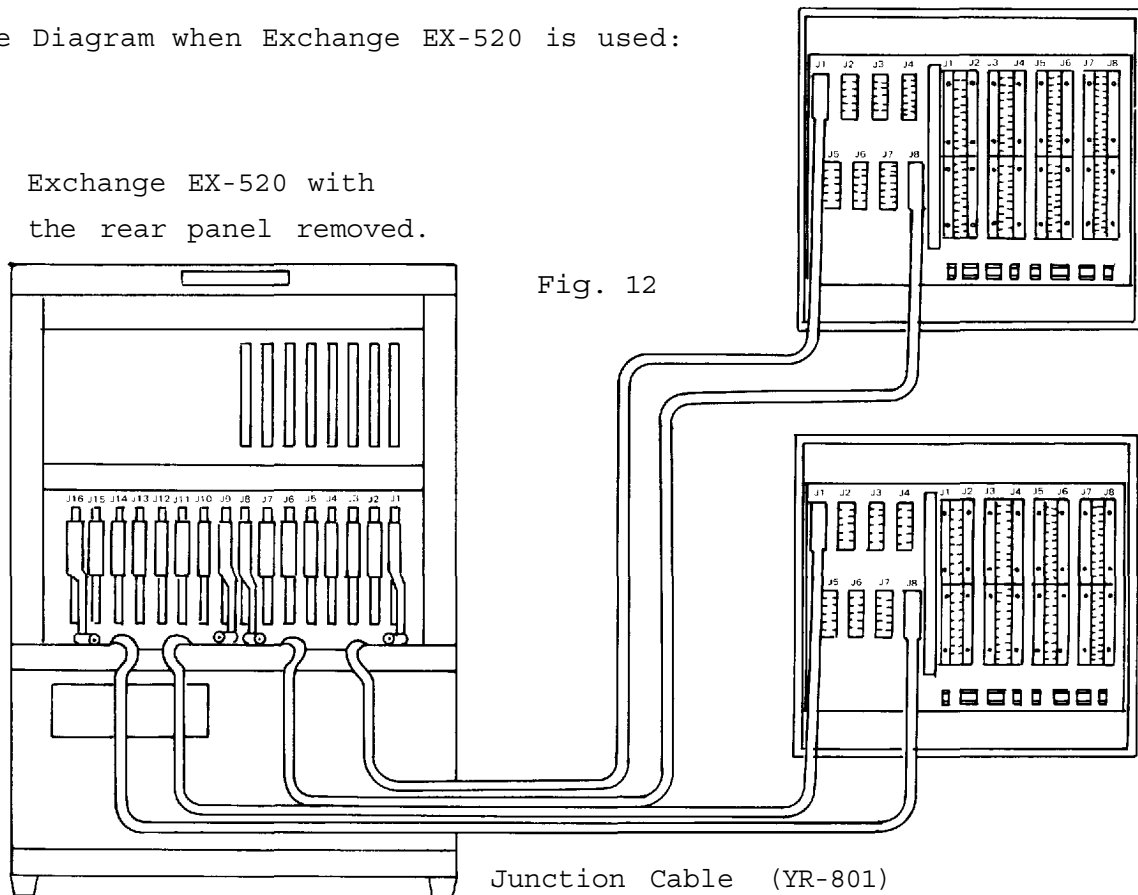

Rear Connector of the Exchange

Terminal Board Side

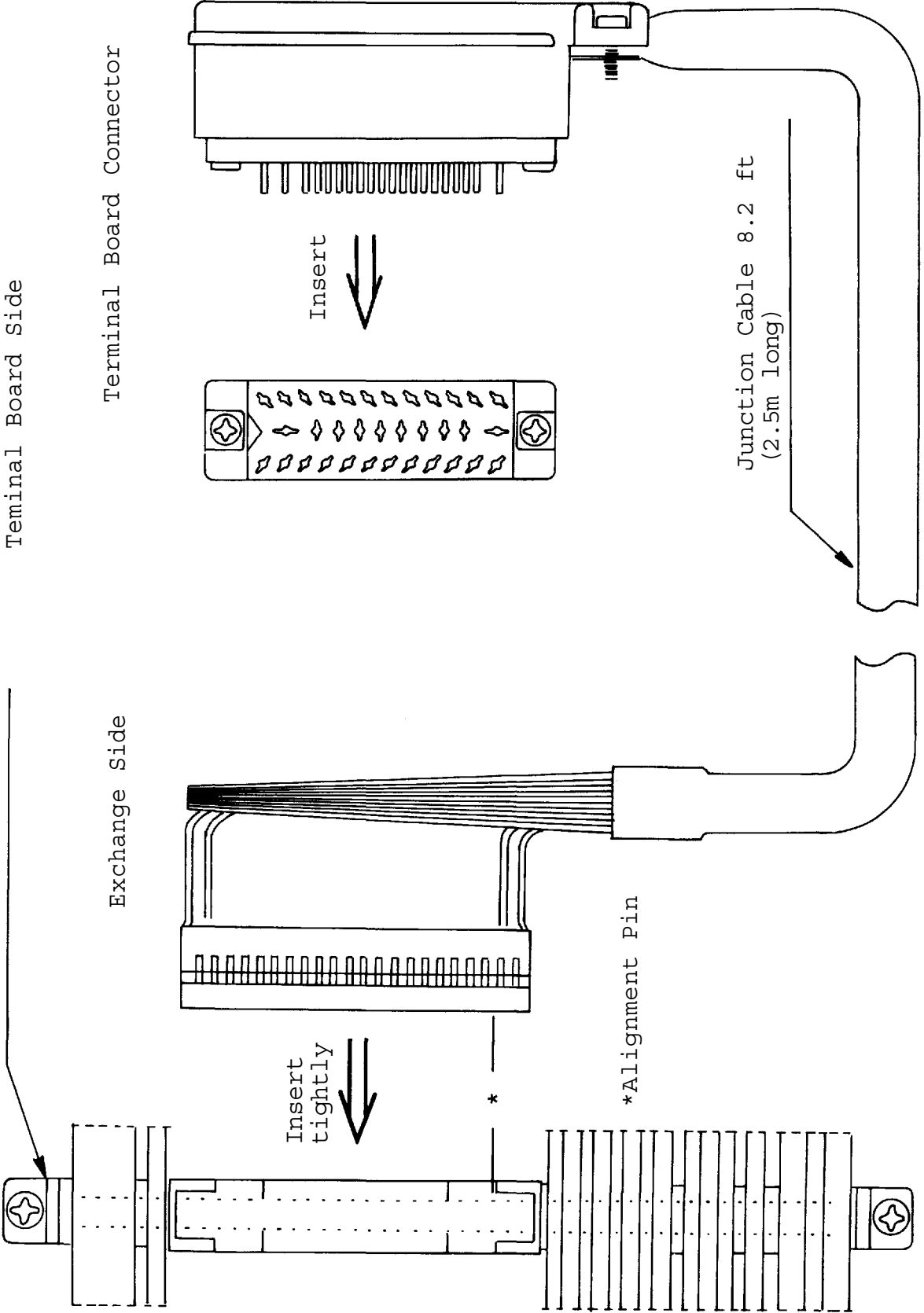

Exchange Side

Terminal Board Connector

Insert tightly

Insert

Junction Cable 8.2 ft  
(2.5m long)

\*Alignment Pin

Fig. 13

Connection of the Terminal Board (BOX-064) to the  
Main Terminal Board

Route cables from the main terminal board to the terminal board (BOX-064) and connect to the individual clip terminals using clipping tool C (Standard accessory).

See Fig. 14 for the diagram of the interior of the terminal board (BOX-064).

Connector J1 is connected to clip terminal J1 on the inside of the terminal board.

Connect the individual cables to the clip terminals following the terminal wiring diagram attached to the door. If the number of circuits involved is 65 or more (or 57 or more if the paging function is to be used), two terminal boards are required. Diagram for connection of up to 128 stations appears on the back of the terminal wiring diagrams and should be followed when installing such systems.

Before mounting the terminal board (BOX-064) on a wall, to make sure that it will fit into the space provided.

(See Fig. 14)

No.	Name
1	Junction Cable Connector (34C)
2	Clip Terminal for Cable Connection
3	Cable Clamp
4	Junction Cable Outlet
5	Knockout Hole for Staffing Line (for 1/2" and 3/4")

Accessory: Clipping Tool C

Specifications of the Clip Terminals

1. Connectable wire (solid wire) size range:
  - 1) Insulated wire  
Core diameter 0.4-0.8mm (1/64"-1/32")
  - 2) Bared wire  
Core diameter 1.0mm (max.) (0.04")
2. Insertion force  
Approximately 6.6 Lbs (3 Kg.) on a copper wire with a core diameter of 0.02" (0.5mm)
3. Can be connected repeatedly.

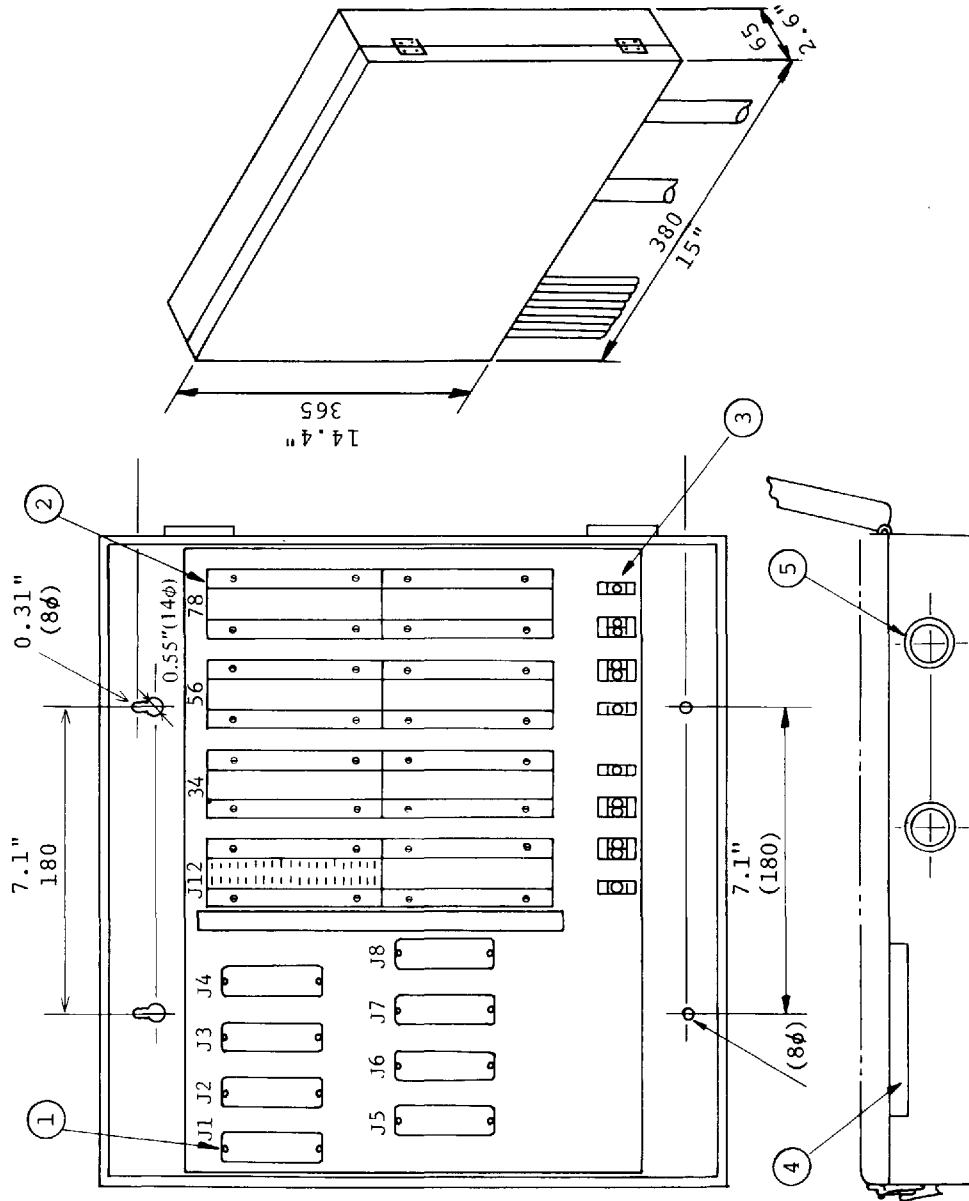

Fig. 14: Terminal Board BOX-064

Connect cables to the clip terminals according to the following procedure:

- \* Remove the cable outside insulation tubing so that the wires are showing. (Cutting through insulation of individual cable wires should be avoided)  
The length of cable insulation to be removed should be 1.5 times the length of the clip terminal.
- \* Clamp the cable in place securely using a clamp.
- \* Leave the insulation on the cable wires and attach cable to the upper part of the clip terminal. Then, holding the excess length of wire in hand, pull it toward the access side and push it down from above the clip terminal using clipping tool C.
- \* The cable connection is complete when the excess wire is cut off.

Connection of the Station Line to the Clip Terminal  
of the Terminal Board (BOX-064)

Note:  
Connect the individual  
cables in order, starting  
with the top terminal.  
When using the clipping  
tool, be sure that the  
cutting edge is on the  
down side.

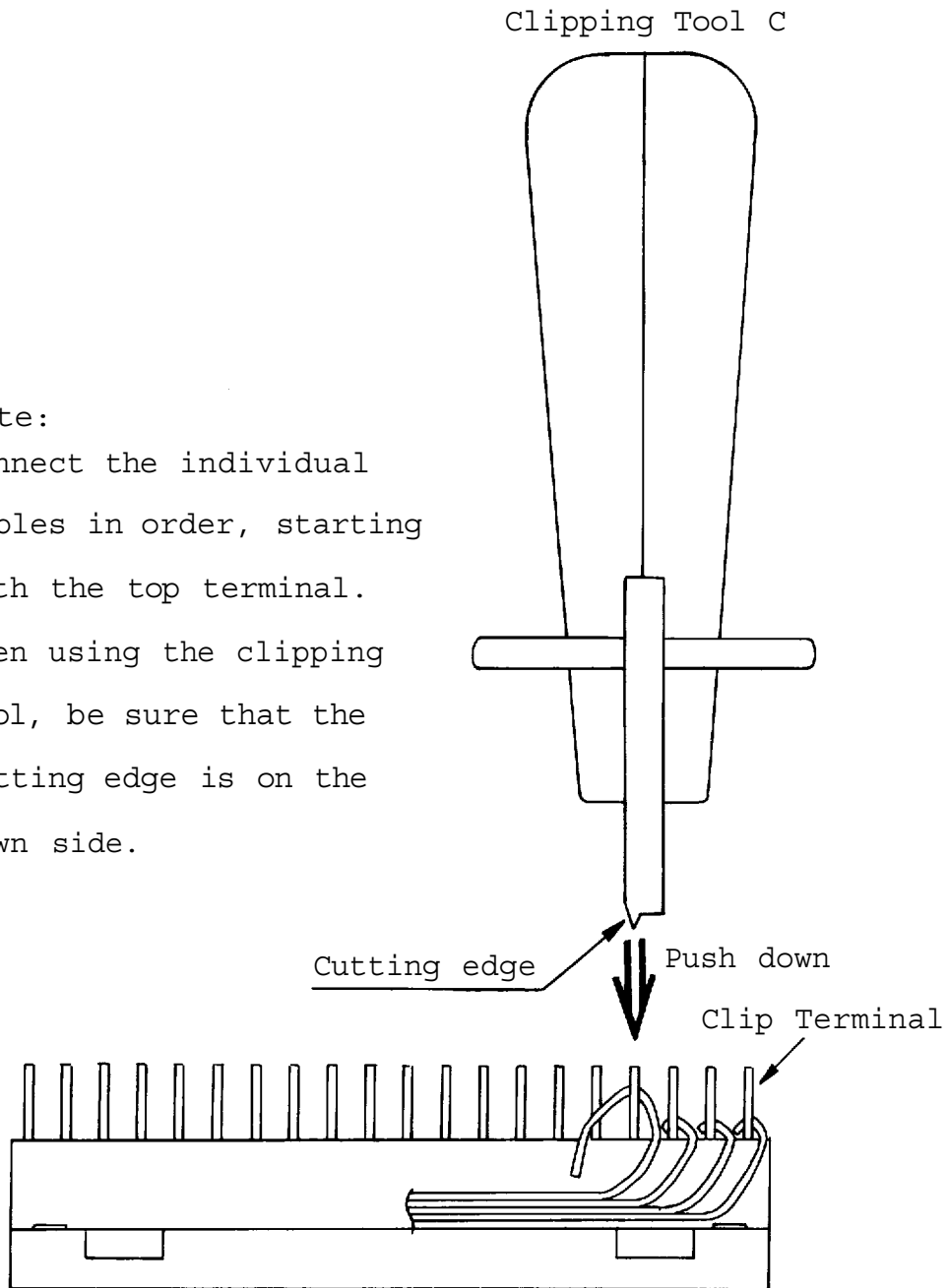
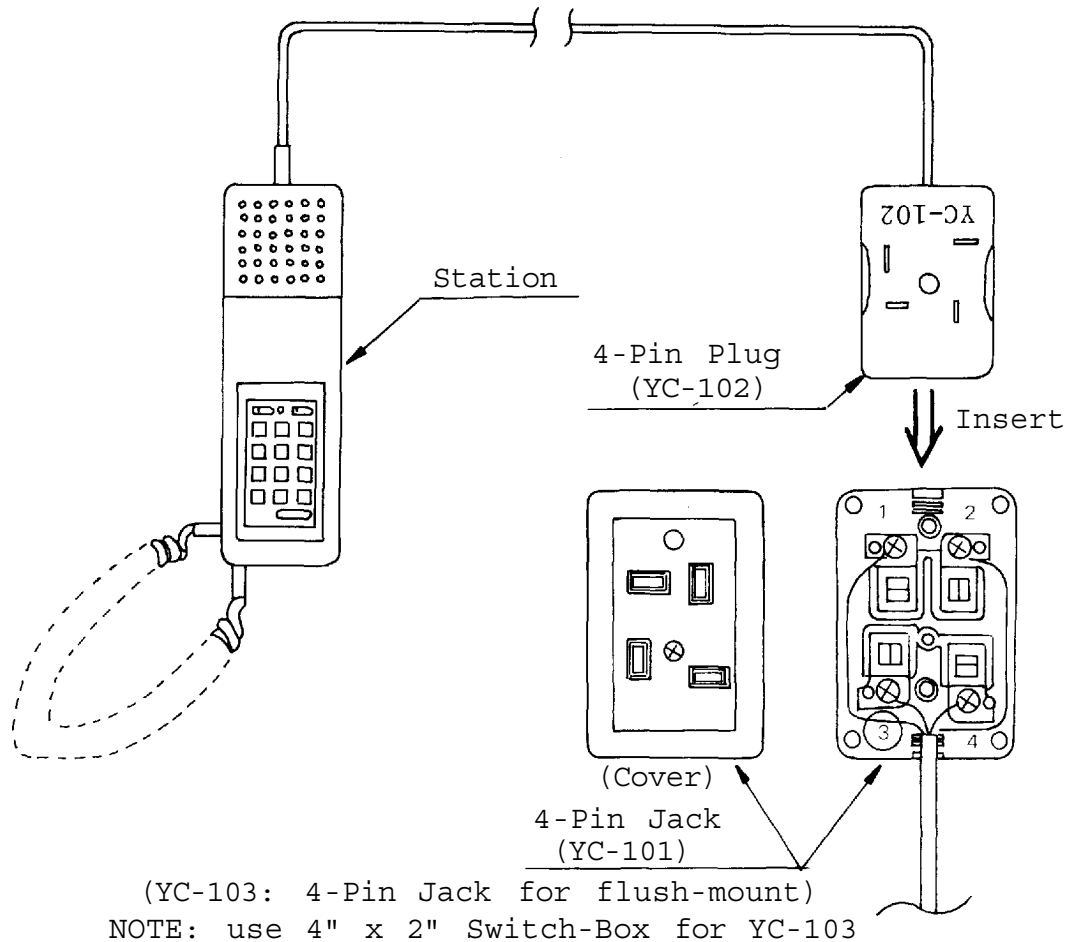

Fig. 15: Clip Terminal (Side View)



4-6. Connection of the Station Plug to the Exchange Jack



1 } Receiving Lines  
 2 } (not Polarity Specified)

3 } Transmitting Lines  
 4 } (not Polarity Specified)

Terminal Board (BOX-064) Clip Terminals

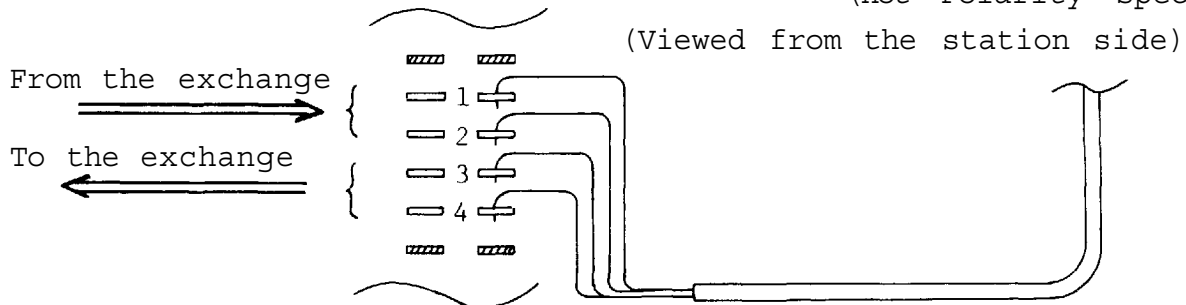

Fig. 16:

#### 4-7. Zone/Group Paging Connection

##### Connection Instruction when Zone Paging Function is Employed

The audio signal line and control line out of PIU module are connected to clip terminal J8 or J16 on the inside of the terminal board. The Fig. 17 shows how to make connections between the terminal board BOX-064 and external PA amplifier.

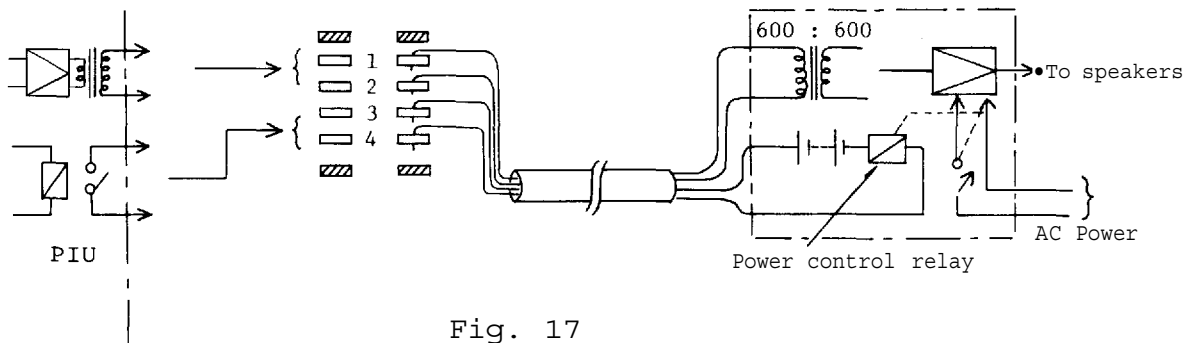

Fig. 17

#### Specifications of each output line

##### 1. Audio signal line

Impedance : 600-ohm, balanced

Output level : -10 dBm

##### 2. Control line

Relay contact capacity

: 30V DC, 0.5A

In case where the length of wiring between the terminal board BOX-064 and external PA amplifier extends over approximately 33 feet (10m), the balanced type should be employed to avoid external noise such as hum. To control the power switch of the external amplifier, do not fail to employ a relay since the

contact capacity of the line is a very small (30V DC, 0.5A). Refer to Fig. 17 and control power switch indirectly with the control line.

#### Connection Instruction when Group Paging Function is Employed

The audio signal lines need to be connected to each group of the LMU modules.

First, take out the LMU modules belong to each necessary group. Open the back cover of the exchange and take out the group paging assignment module carefully by inserting a screwdriver into a slot next to the module.

In the LMU modules, numbers are arranged so that, when viewed from the parts side with the connectors on the left, station numbers run from top downward, for example, #200 - #207.

In the PIU modules, numbers are arranged so that, when viewed from the parts side with the connectors on the left, paging numbers run from top downward, for example PO ~ P7.

Figures 18-1 and 18-2 show the circuits from the LMU and PIU modules that are needed for the group paging function.

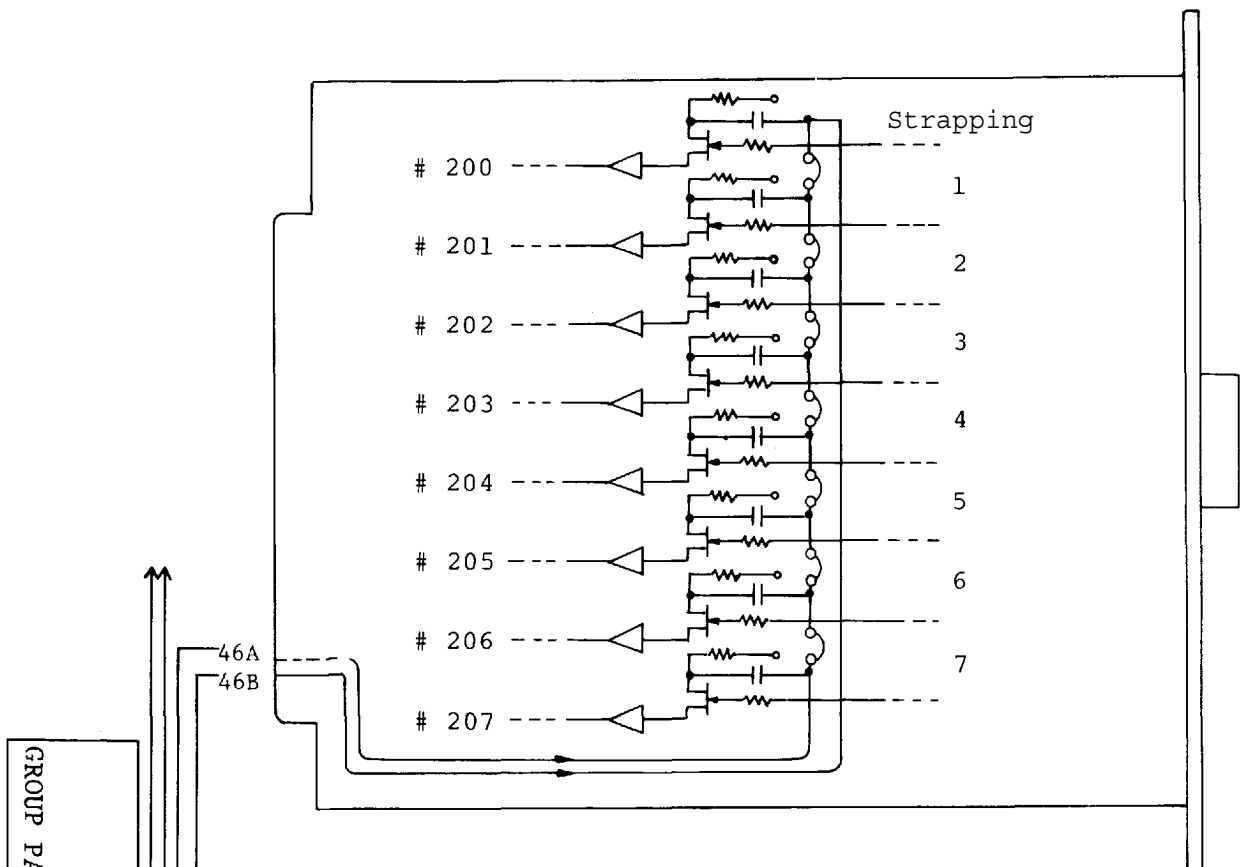
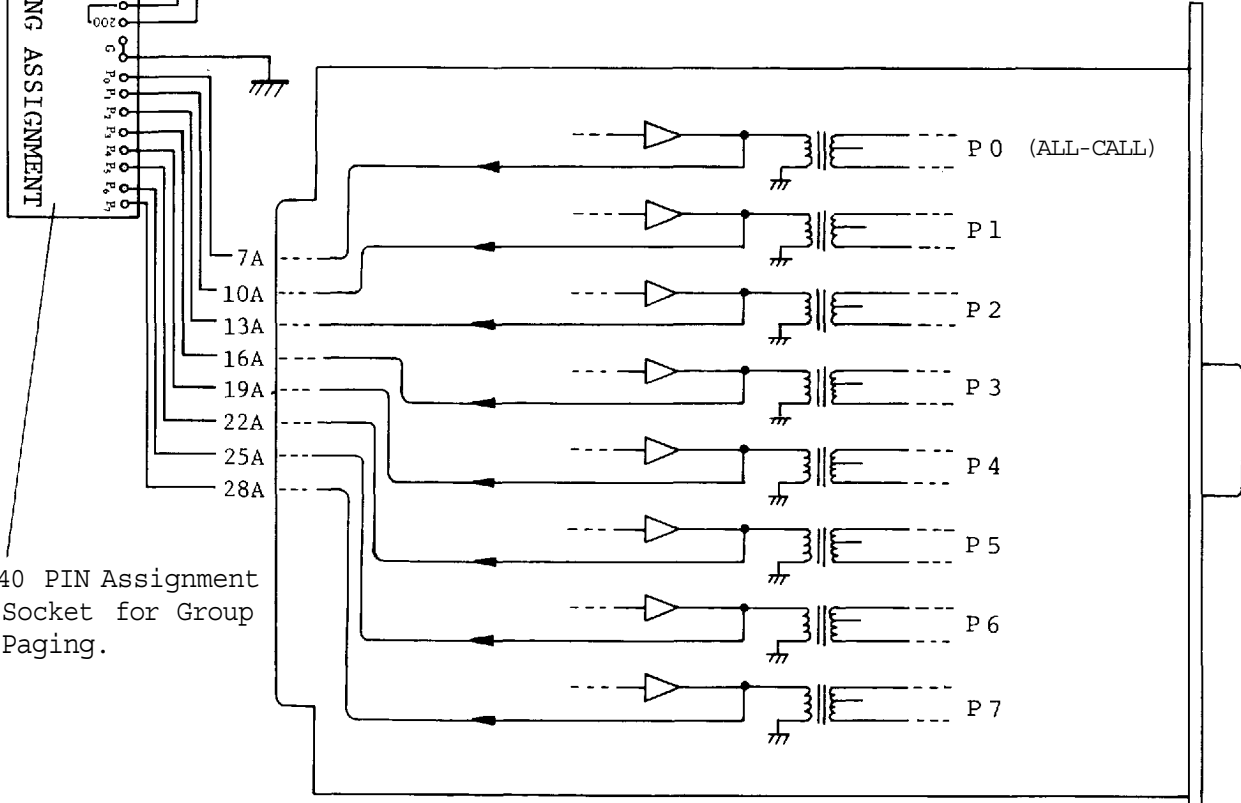

Fig. 18-1 LMU



40 PIN Assignment Socket for Group Paging.

Fig. 18-2 PIU

Example:

When #200 ~ #205 are in Group P<sub>1</sub>,  
#206 ~ #220 are in Group P<sub>2</sub>,  
#223 ~ #231 are in Group P<sub>3</sub>,  
#232 ~ #239 are in Group P<sub>4</sub> layout is as follows:

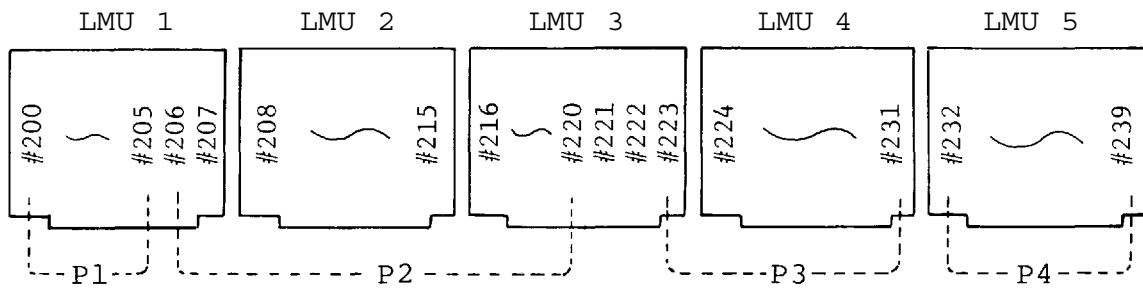
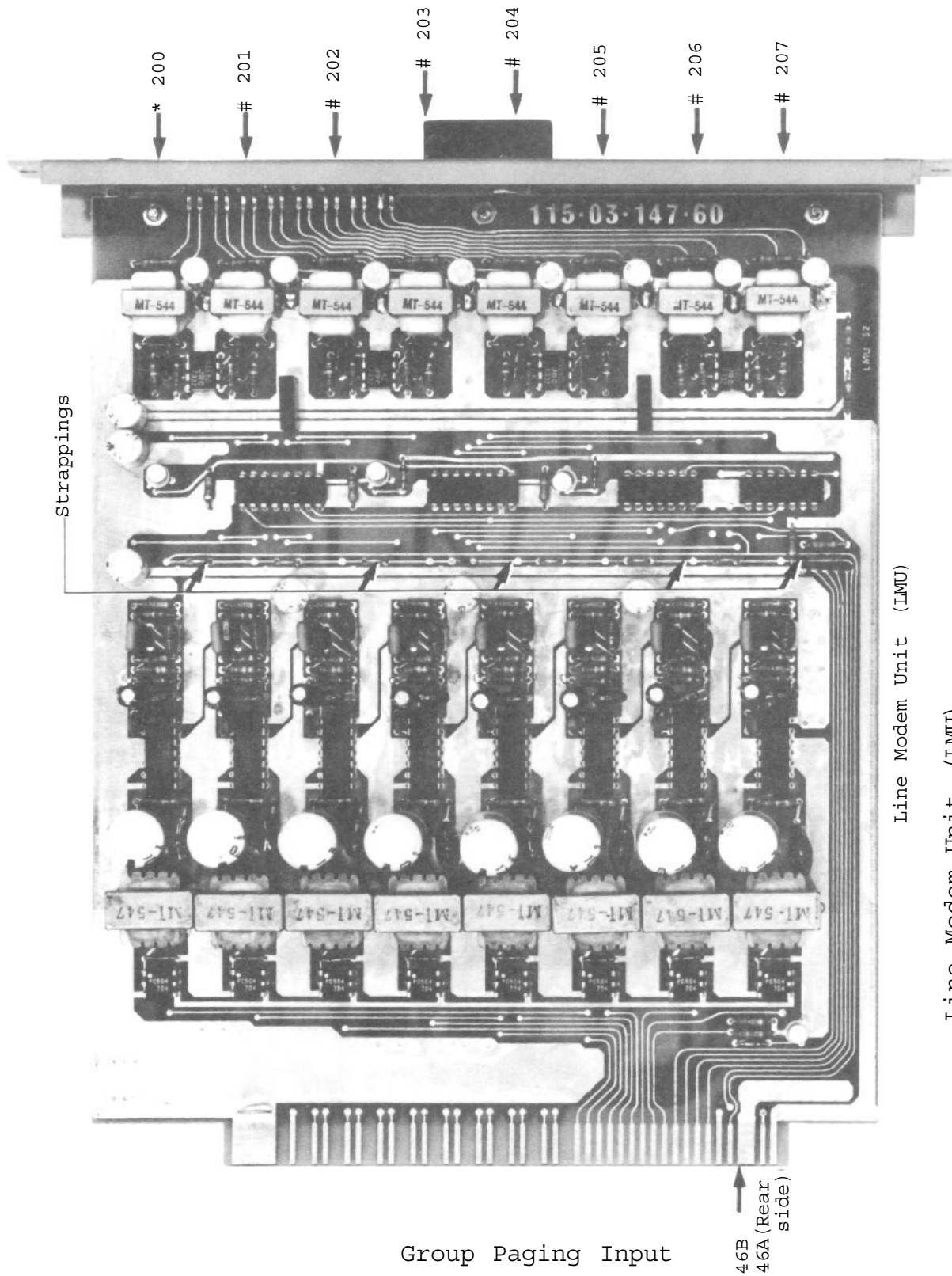

Fig. 19

Station numbers covered by the individual LMU modules are indicated in Fig. 19. Grouping of the station numbers is indicated by the broken lines.

Jumper wires 6 for LMU 1 (#200 ~ #207) and  
Jumper wires 5, 6, and 7 for LMU 3 (#216 ~ #223)  
are to be cut off.

This accomplishes separation of each group on the LMU modules. The station numbers not included in group paging need to be separated by cutting the strapping wires.



Line Modem Unit (LMU)

Line Modem Unit (LMU)

The input lines (46A and 46B of the connector of LMU) of LMU 1 ~ LMU 7 (#200 ~ #256) for EX-510 and LMU 1 ~ LMU 15 (#200 ~ #319) for EX-520 are connected to the group paging assignment socket.

The group paging output lines from PIU (7A, 10A, 13A, 16A, 19A, 22A, 25A, and 28A of the connectors of PIU) are also connected to the group paging assignment socket.

Therefore, connections are needed on the group paging assignment plug for the terminals.

The connections for the example is shown in Fig. 20.

Solder jumper wires or lapping wires for connection.

When connecting wires check the following:

- \* There are two wires from each LMU module to group paging assignment socket.

For prevention of noise in the line, if there is any unconnected terminal and/or terminal that is not used in group paging, connect them to GND,

- \* If groups lap between more than two LMU modules, connect the terminals. In such case, only one terminal of a group has to be connected to the output line terminal.

Since the group paging assignment plug is small, be careful not to short-circuit or to break pins.

After connecting, insert the assignment plug into the socket of the 40 PIN IC.

This will complete the connection of group paging.

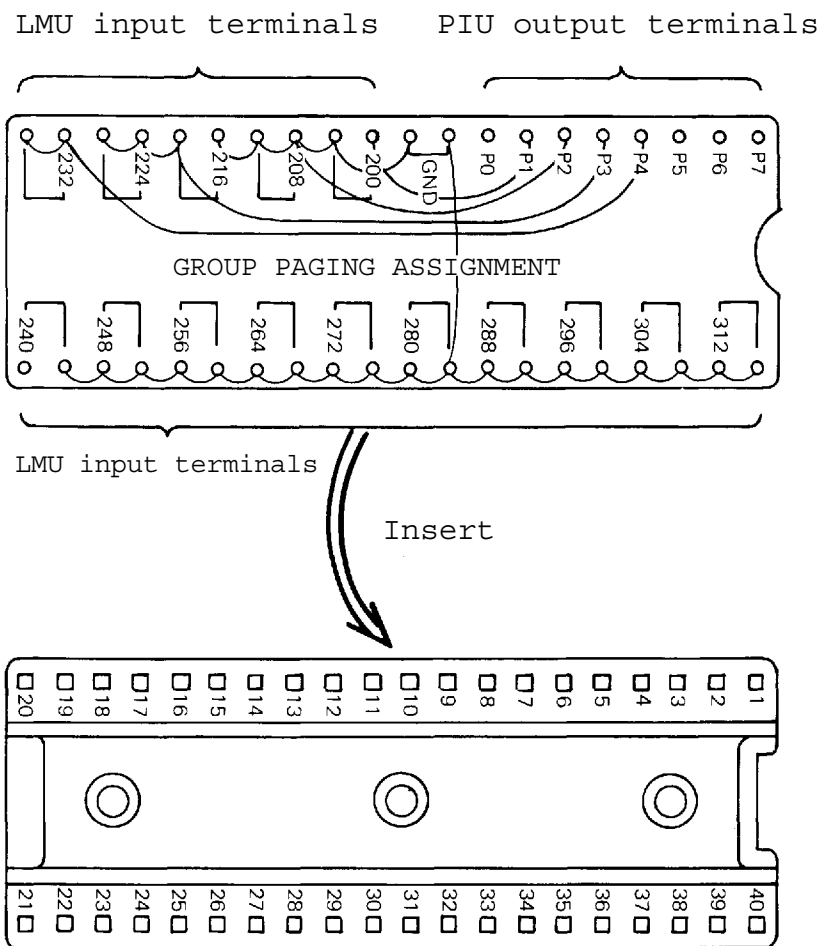

Fig. 20 Group Paging Assignment and 40-Pin IC Socket

#### 4-8. Connection of Power Supply

The connection on the terminals of the power section is illustrated next page Fig. 21.

When batteries are to be connected, connect the connector after plugging into the AC power source.

Connect to the AC power source, as illustrated below, after setting the system.



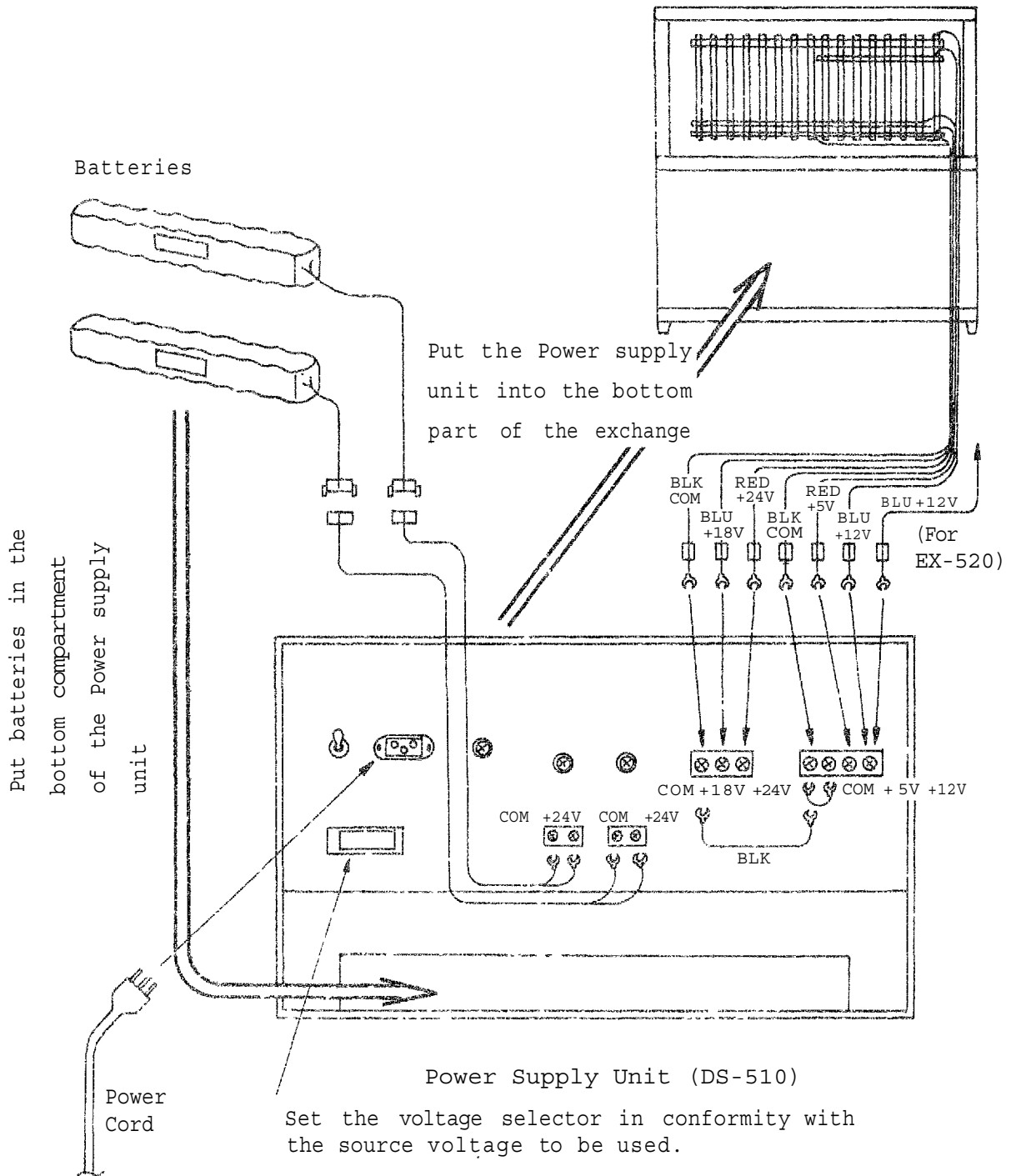

Fig. 21

5. Programming of "secretary transfer", "master/sub-station", and/or "executive priority" functions

After confirming that the system is working correctly, register "secretary transfer", "master/substation", and/or "priority" functions.

Use station #200 for the programming.

Determine the station numbers before registering.

\* For "secretary transfer" function;

Determine the station numbers of the executive and his secretary.

\* For "master/substation" function;

Determine the station numbers of the master-station and of corresponding sub-stations

\* For "executive priority" function;

Determine the station number of the privileged station.

The following shows how to register the functions:

Flow Chart of Programming at Station No. 200

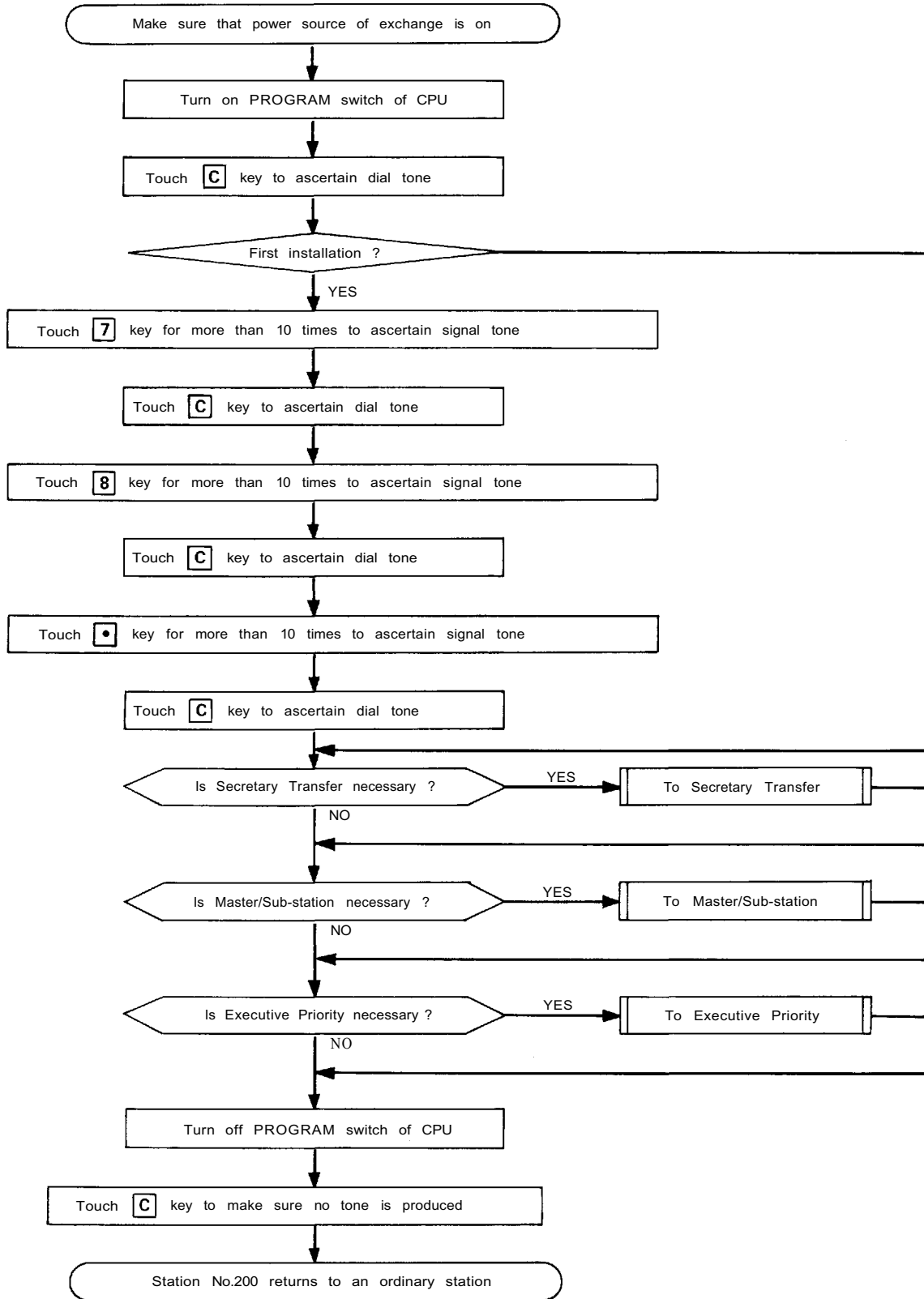

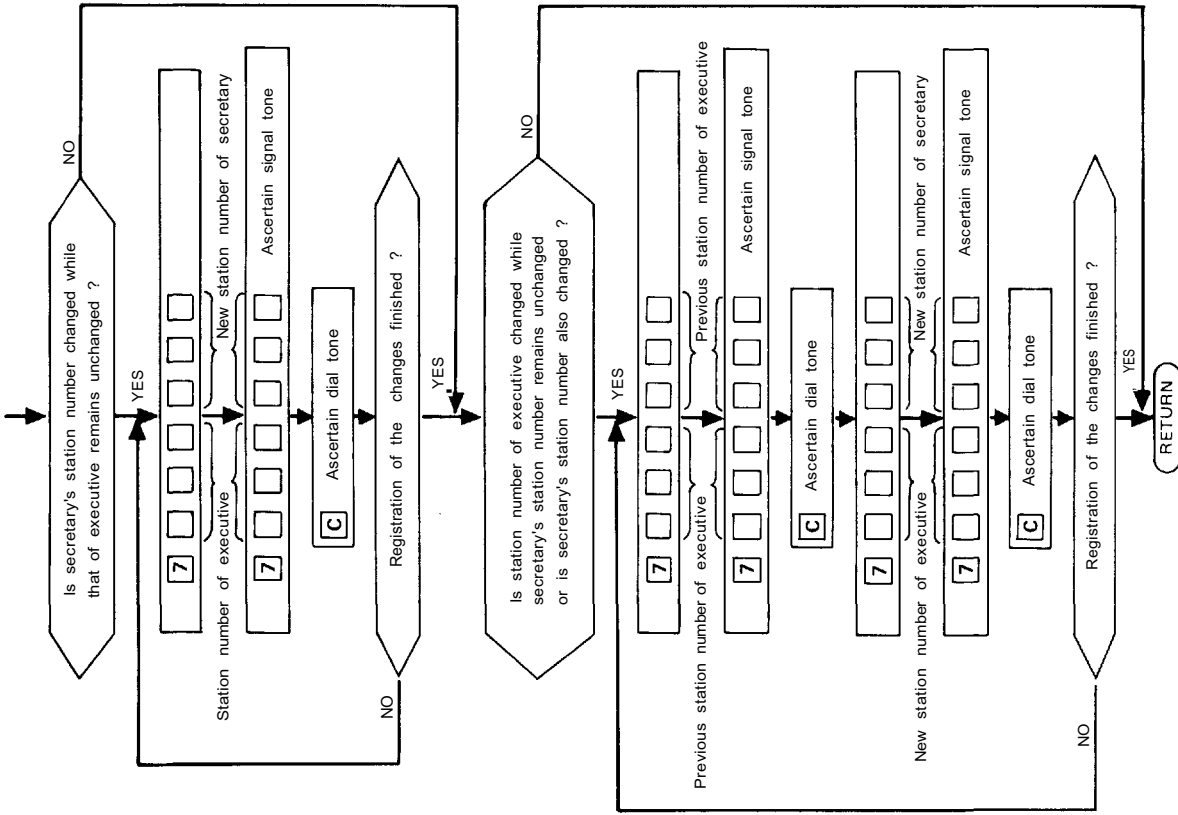

Remarks: In the event of failure to touch keys for correct dialing, touch "C" key to ascertain dial tone and re-start from the beginning.

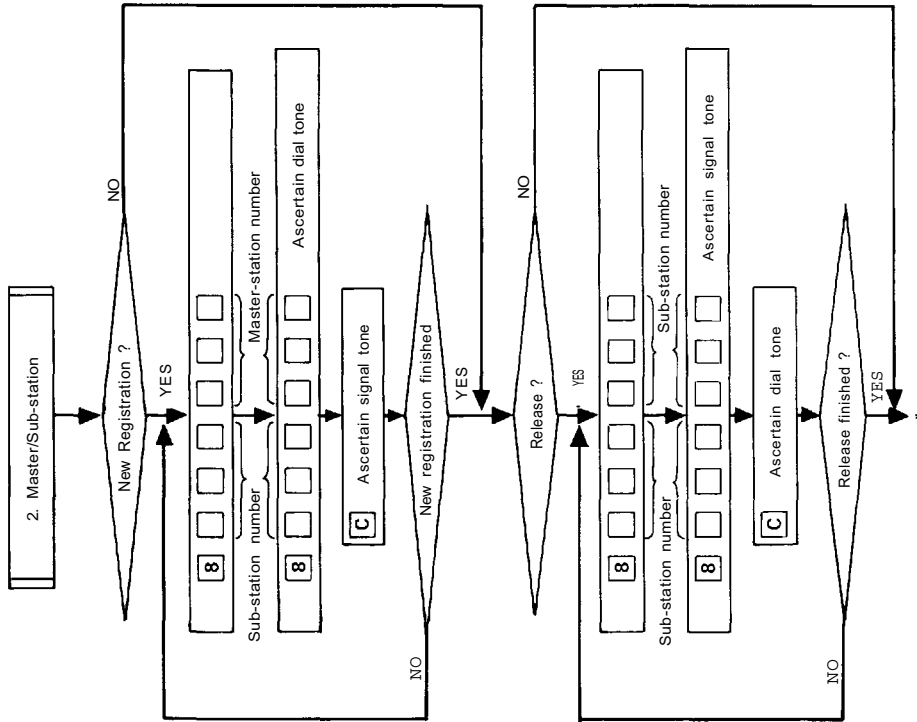
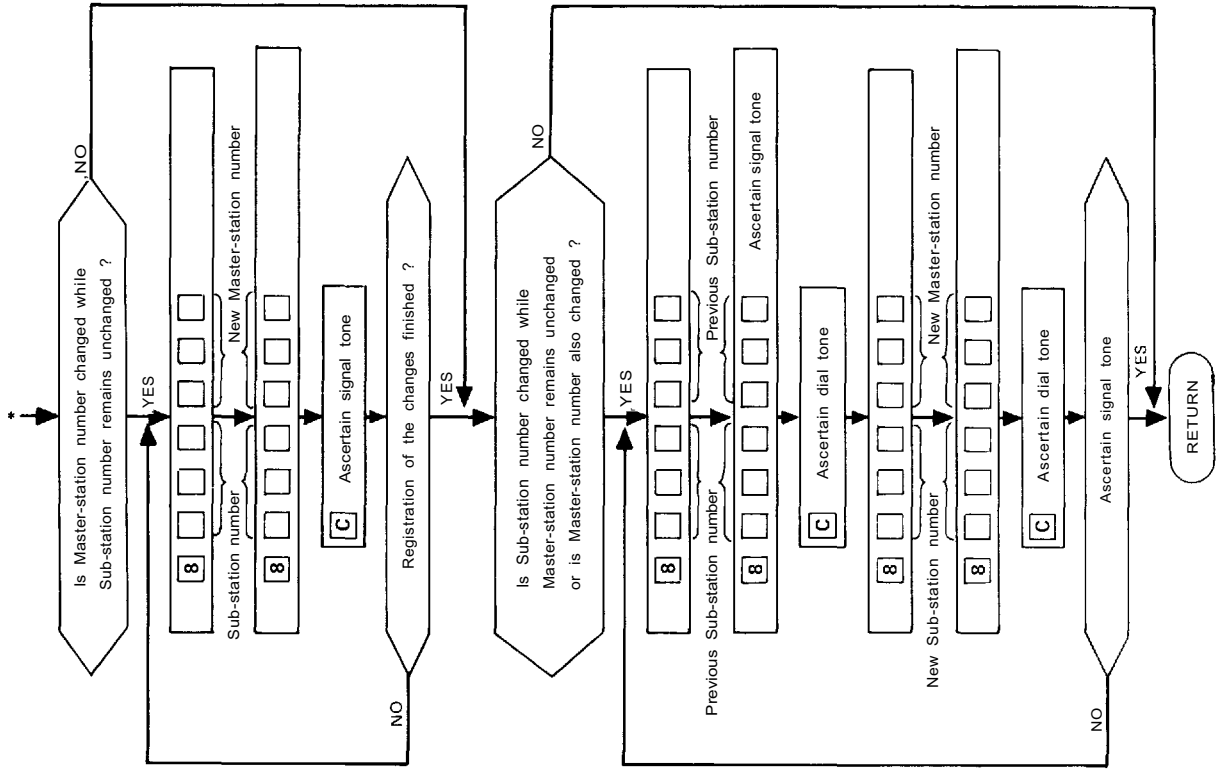

Remarks: In the event of failure to touch keys for correct dialing, touch "C" key to ascertain dial tone and re-start from the beginning.

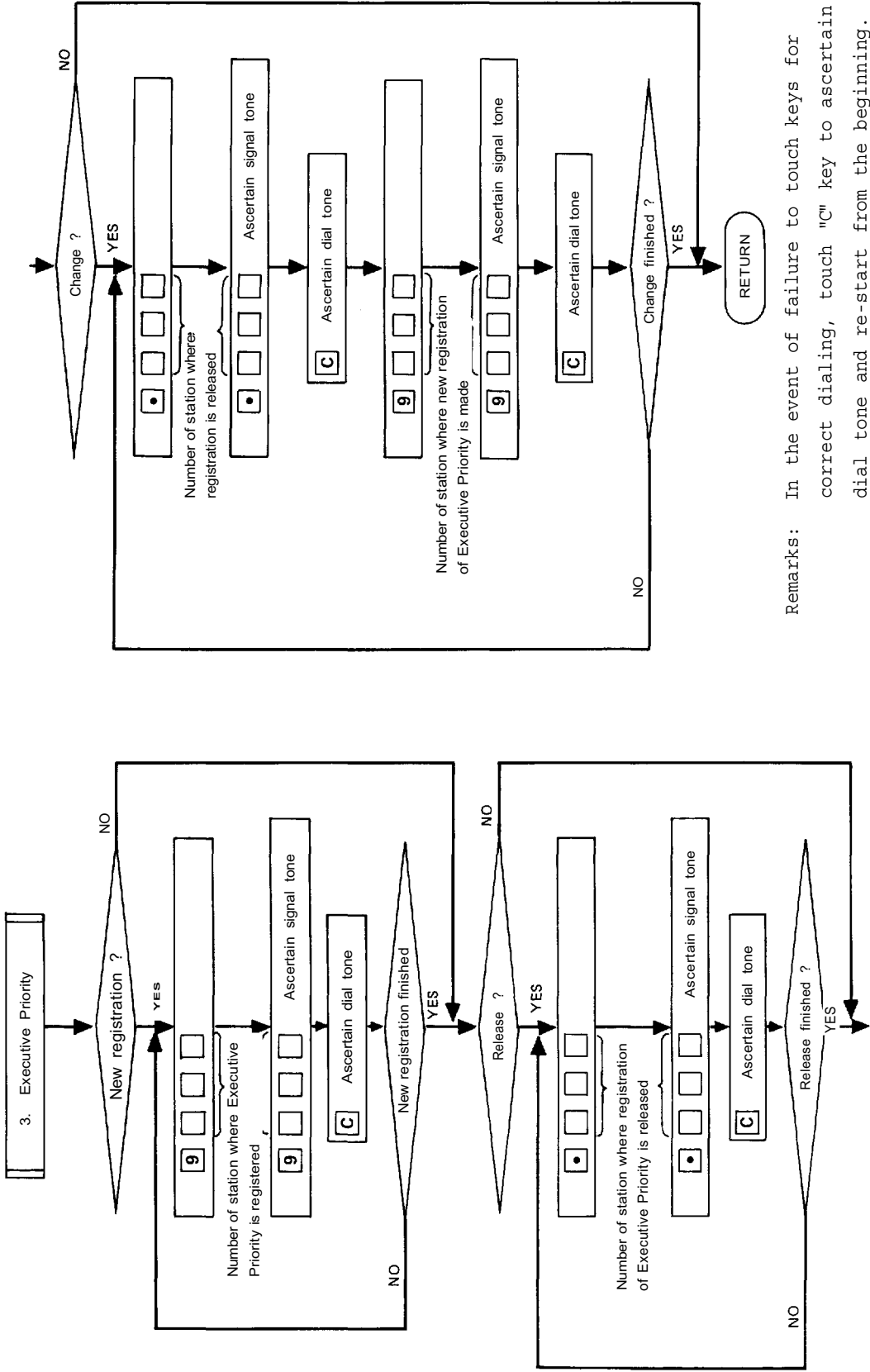

Remarks: In the event of failure to touch keys for correct dialing, touch "C" key to ascertain dial tone and re-start from the beginning.

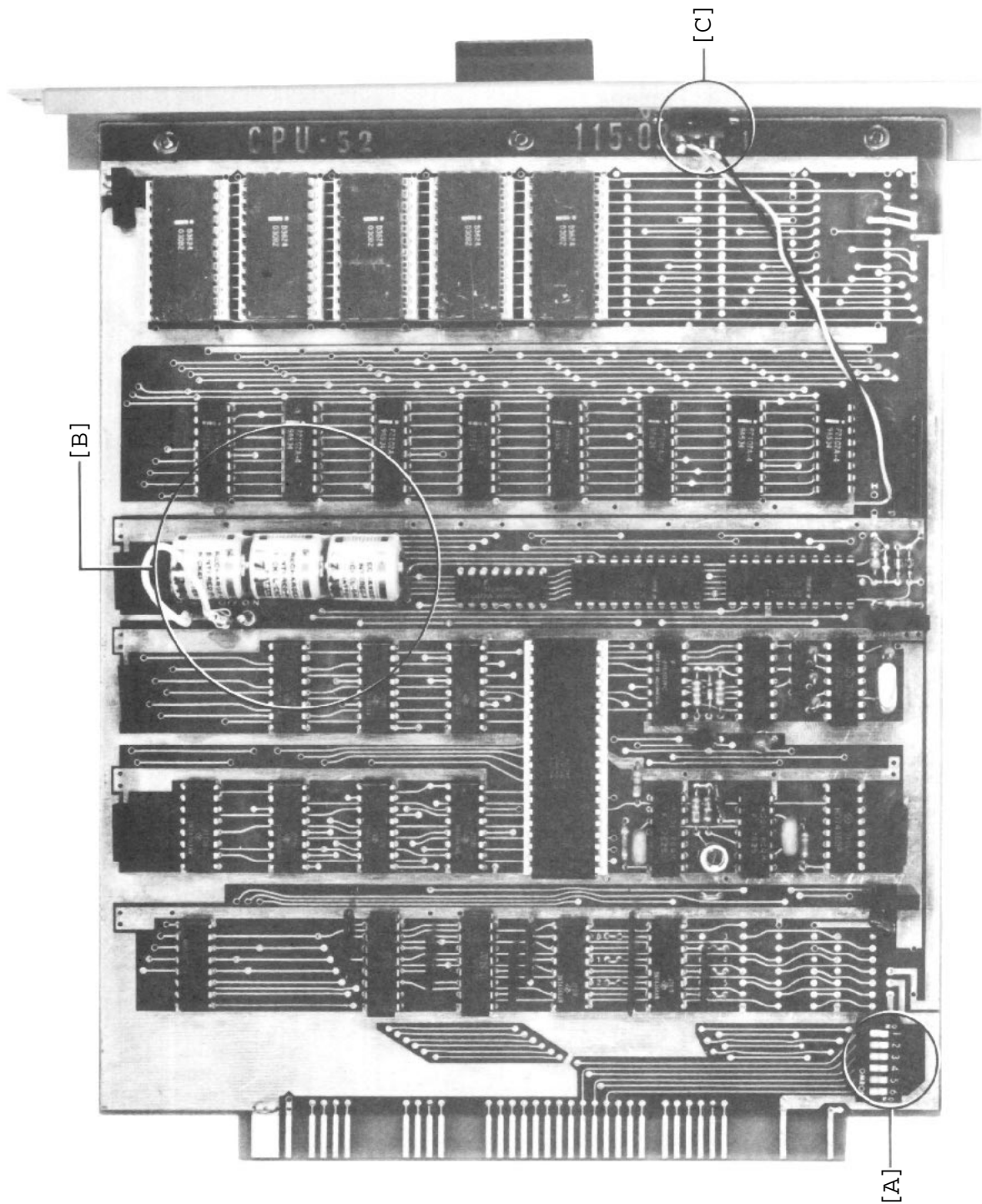

Photo of CPU

6. Adjustment of the CPU modules (Refer to CPU Photo on Page 53)

- \* Take out the CPU module for adjustment before use.
- \* The picture below shows the mounting side of the CPU module.
- \* The numbered sections in the picture require adjustment.  
The adjustment method is as follows:

[A] DIP switch

These switches select the CLU and/or DLU modules to be used, adjust the time interval before the start of the paging signal, and switch on "programming" of 3 special functions.

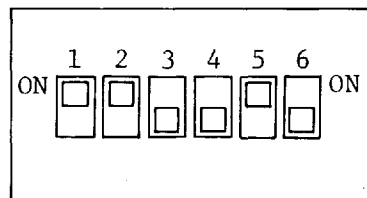

("OFF" When the switch is down.)

Fig. 23 (PHOTO [A])

1. Turn on when DLU 1 or CLU is used.
2. Turn on when DLU 2 is used.
3. Turn on when DLU 3 is used.
4. Turn on when DLU 4 is used.
5. Adjusts the time interval before the start of the paging signal.

ON : Paging signal begins a few seconds after the paging function is activated.

OFF : Paging signal begins immediately after the paging function is activated.

This adjustment is used to take into account the



time needed to warm up the paging amplifier, so the switch can be in either position when the paging function is not being used.

6. This switch activates "Programming" of the "Secretary transfer", "master/substation", and/or "executive priority" functions at station #200. However, since the "PROGRAM switch", which fulfills the same function, is provided on the front panel of the CPU model, this switch does not have to be used, and should be kept in the OFF position.

[B] Connecting Jack for back up battery

This jack serves as the connection to the back up batteries and therefore prevents cancellation of the function of functions (one or more of the 3) programmed at station #200 in the event of a power failure or the accidental disconnection of the exchange from its power source. (In the illustration Fig. 23, the three cylinders lined up next to the connecting jack are the back up batteries.)

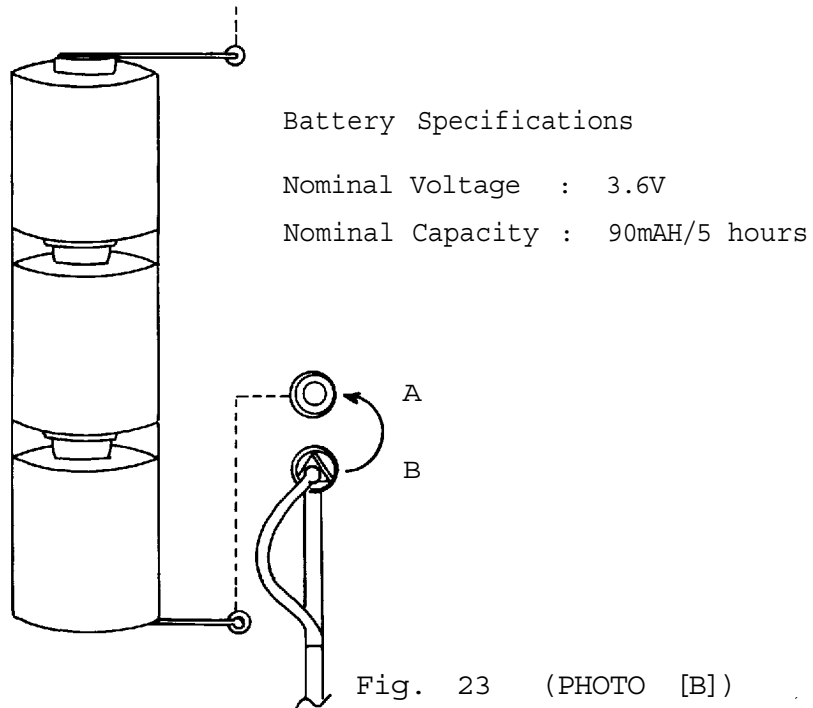

During delivery, the batteries are connected as illustrated above to prevent unnecessary discharge.

Insert the jack into the pin A.

By so doing, the batteries will be connected and will safeguard the programming of the special functions.

Note: Connect the batteries just before turning the exchange power switch on.

Be careful not to short-circuit the batteries.

[C] Program Switch

This switch makes station #200 a programming station, that is, it directs station #200 to program the "secretary transfer", "master/substation" and/or "executive priority" functions.

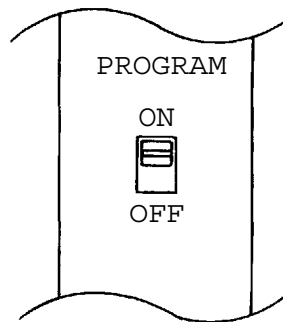

Use a small screw driver to change the switch setting.

Fig. 24 (PHOTO [C] )

ON : Station #200 becomes the programming station.

Calls from other stations will not be transmitted to station #200 during the time it is functioning as a programmer.

This setting, however, has no effect on other stations.

OFF : Station #200 acts as an ordinary station and can accept calls.

Before turning this switch on, be sure to study the "Instructions on Programming" given in this manual.

Note : Before using this switch, be sure that the system is functioning properly.

Be sure that this switch is in the OFF position during ordinary operation.

## 7. Inspection

### 7-1. Inspection before Power on

- \* Before turning on the switch, check if the power cord is plugged in and the fuse is in place. All the modules should be placed and secured. Make sure that the connection of exchange and stations are completed.
- \* Turn on the switch on the back of the exchange.
- \* AC indicator lamp on the front of the exchange should be on. If not, electricity is not supplied. Turn off the switch and check the cord and fuse.
- \* Handle Plug-in units with care; plug-in units incorporate CMOS. After the exchange is plugged in, do not attempt to disconnect the plug-in unit.
- \* If you wish to connect batteries, do so at this point. Connect the cord from the power source. Use 2 batteries: voltage; 24V, capacity; 3.5AH.
- \* With batteries connected, the unit automatically switches to battery operation when AC power source is cut off. DC indicator lamp will be on accompanied by buzzer. To stop the buzzer, push the buzzer reset switch.

## 7-2. Operation and Function Testing

Pick out a convenient station and call all the stations connected on the exchange and check the volume and statics.

Volume of dialling tone and talking tone can be adjusted by the volume control on the back of the station. Use a small screwdriver; turn clockwise for maximum, and counterclockwise for minimum volume. There is also a volume switch on the keyboard of the station for the user.

Paging volume should be adjusted to eliminate feedback, using a station closest to the paging speaker. While testing for operation, check all the functions listed in the operational instructions.

## 8. TROUBLE SHOOTING GUIDE

Repairing of the EXES-5000 system is basically done by replacing defective units with good ones. The system's faults in an installation can be divided into the following categories.

1. Faults in an exchange
2. Faults in a station
3. Cable faults

To make system repairing easier, find which category is involved, then refer to the chart below for assistance in fault finding.

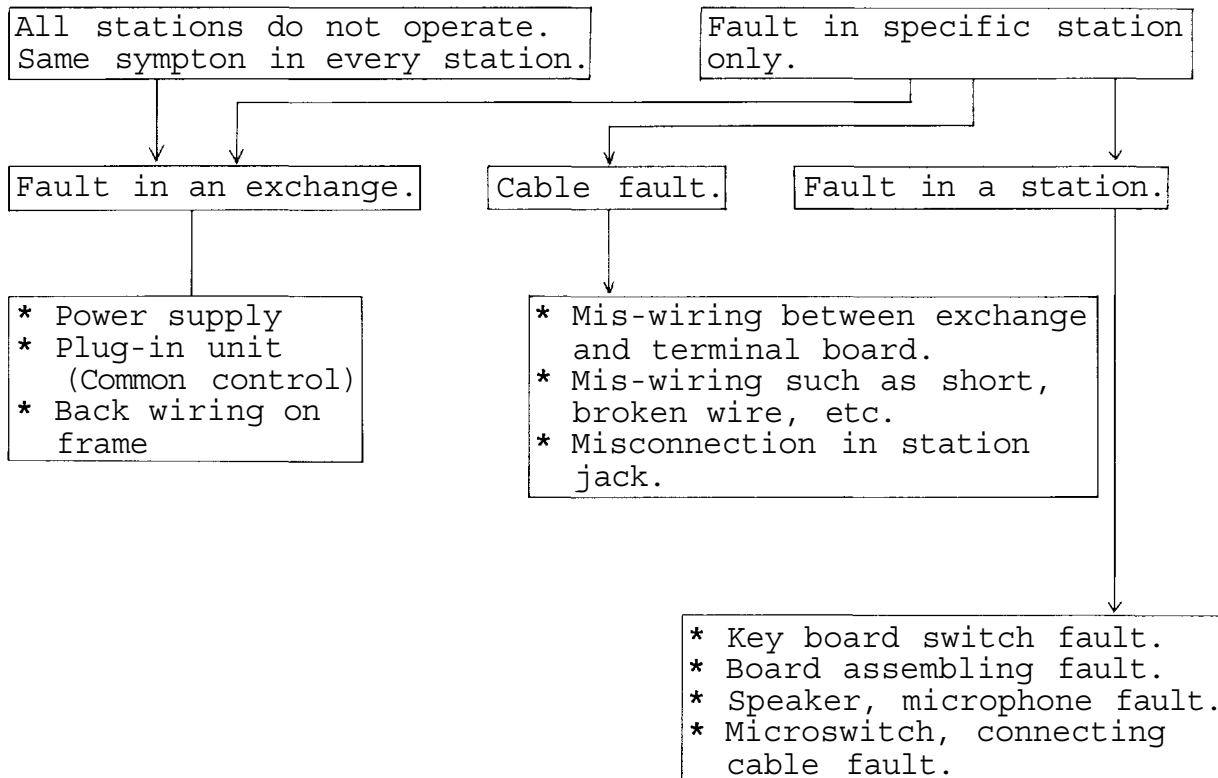

EXES-5000 SYSTEM CHECK FLOW CHART

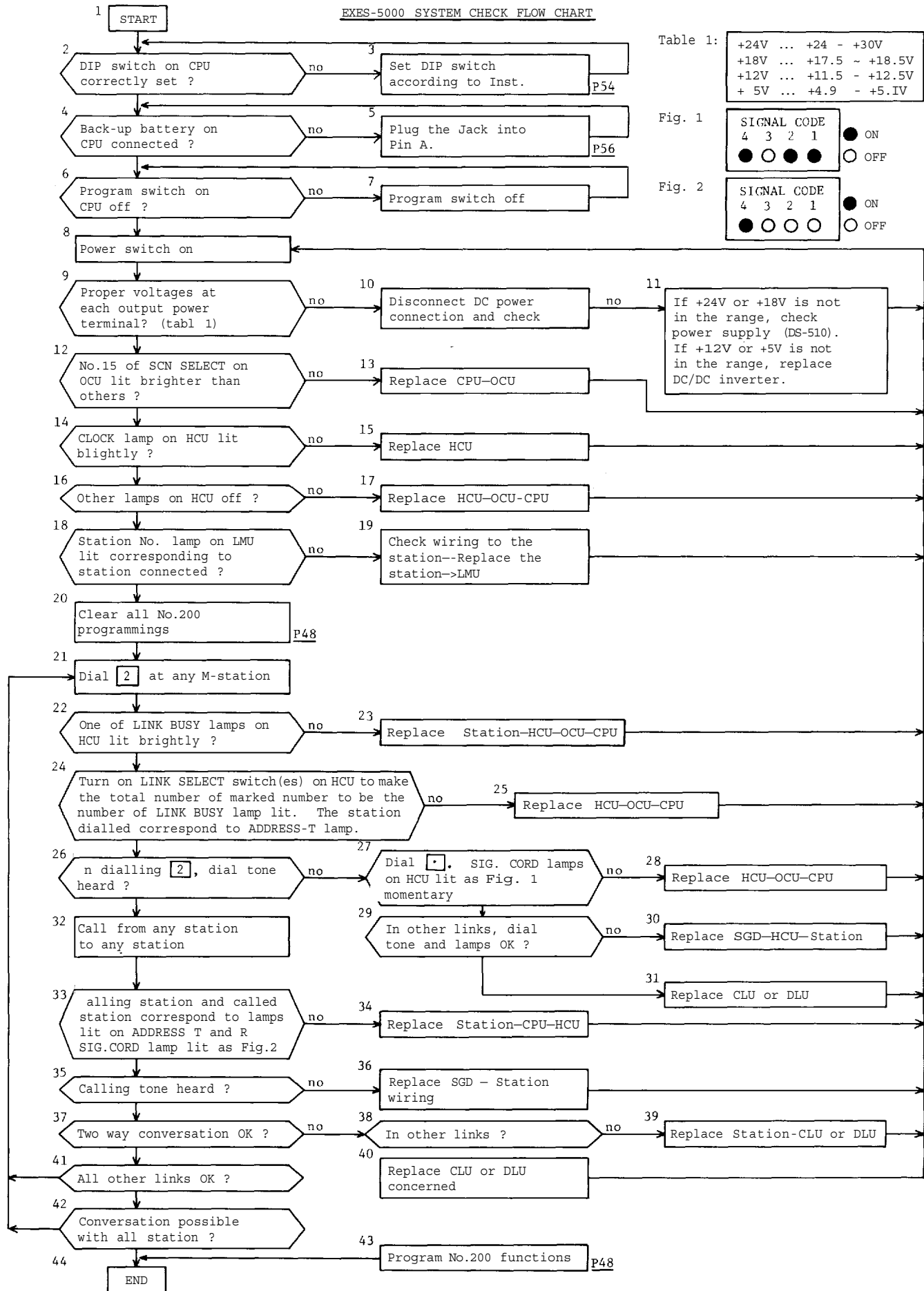
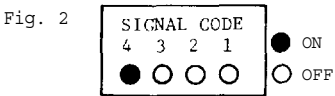
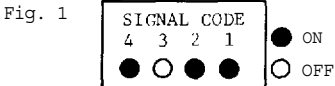

Table 1:

+24V ...	+24 -	+30V
+18V ...	+17.5 ~	+18.5V
+12V ...	+11.5 -	+12.5V
+ 5V ...	+4.9 -	+5.1V



8-1. FAULT IN EXCHANGE

Before power supply check, confirm the following three points to eliminate elementary faults:

1. Is voltage selector set correctly?
2. Is AC power supplied?
3. Is power switch ON?

Start checking after disconnecting all wiring connected to DC output of the power supply unit.

SYMPTON	CHECK-ITEM									
Exchange does not operate.	All DC output voltages are correct.	* Over-current flows into one of plug-in units.								
	All or one of DC output voltages are not correct.	* Fault in the power supply unit DS-510.								
Abnormal voltage of +24V terminal.	Right range: +24 ~ +30V	* Replace AC and DC fuses. * Incorrect setting of the voltage selector. * Faulty power transformer.								
Abnormal voltage of +18V.	Right range: +17.5 ~ +18.5V	* Faulty 2SA-753. * Faulty $\mu$ A7818KC.								
Abnormal voltage of +5V or +12V.	Right range: +4.9 ~ +5.1V +11.5 ~ +12.5V	* DC/DC inverter (MIV-02) is defective.								
Battery is not charged.	Check the current flowing into the battery. Right range: 80 ~ 120mA	* Replace PCB of charging circuitry.								
AC & DC operation lamps are OFF. Buzzer does not operate. Note: Only when DC power supply (Battery) is employed.	Check all DC voltage.	* Replace PCB of charging circuitry.								
Blown AC and/or DC fuse.	All DC output voltages are correct.	* Over-current flows into one of plug-in units. (Especially on +18V)								
	Check all stations involved in All-Call paging.	* MIV-02 is defective. * Replace fuse according to the following.								
		<table border="1"> <thead> <tr> <th>Number of stations</th> <th>Fuse</th> </tr> </thead> <tbody> <tr> <td>0 ~ 30</td> <td>DC 5A</td> </tr> <tr> <td>31 ~ 64</td> <td>DC 7A</td> </tr> <tr> <td>65~</td> <td>DC 10A</td> </tr> </tbody> </table>	Number of stations	Fuse	0 ~ 30	DC 5A	31 ~ 64	DC 7A	65~	DC 10A
Number of stations	Fuse									
0 ~ 30	DC 5A									
31 ~ 64	DC 7A									
65~	DC 10A									



8-2. HOW TO FIND SHORT BETWEEN T-LINE AND R-LINE

If the shorted condition between T-line and R-line is not corrected for a long time, it may burn out the guard resistor (330ft 1/2W) on the LMU board. Therefore, find the shorted line according to the following procedure:

1. Turn off the privacy switch on all stations in the system.
2. Turn on the power switch of the system for several seconds, then, turn it off.
3. Watch the lamps on the LMU panels. The lamps on normal lines will go off after approximately 0.5 second. The lamps on the shorted lines will stay on more than 0.5 second.

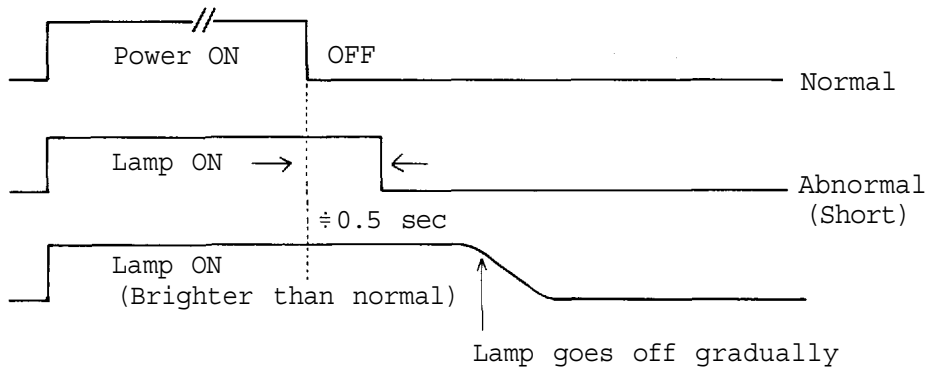

1. One of transmitting lines (T-Line) is disconnected.

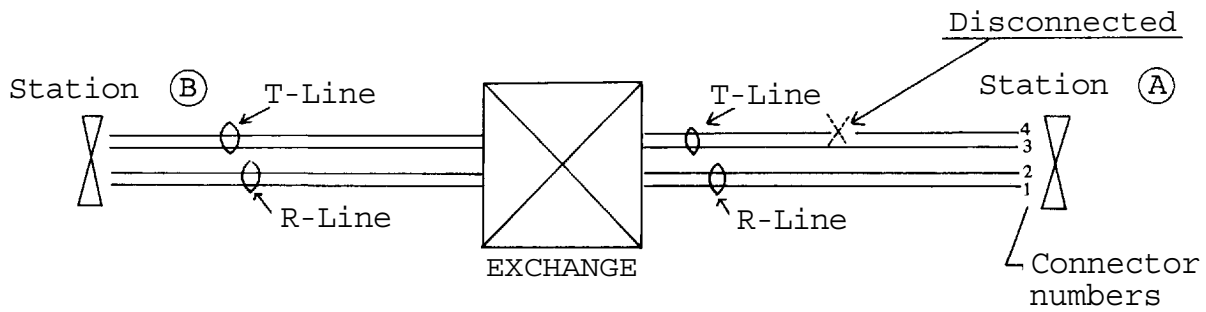

Symptom: 1-1 A can make dialing.  
 1-2 A can hear B.  
 1-3 B can not hear A.  
 1-4 Noise is heard at B.  
 1-5 Noise increases at B when Press-To-Talk bar is pressed at A.

LMU Lamps ----- Normal

2. One of receiving lines (R-Line) is disconnected.

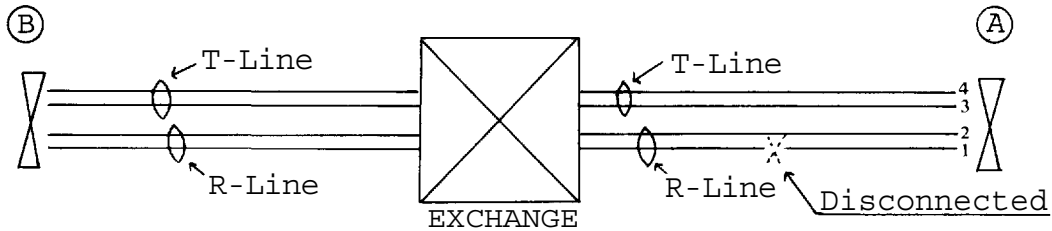

Symptom: 2-1 A can make dialing without dialing tone.  
 2-2 When B dials A, busy tone or dial tone will be heard at B immediately after the calling tone.

LMU Lamps ----- Normal

3. T-Line and R-Line are shorted or mixed up.

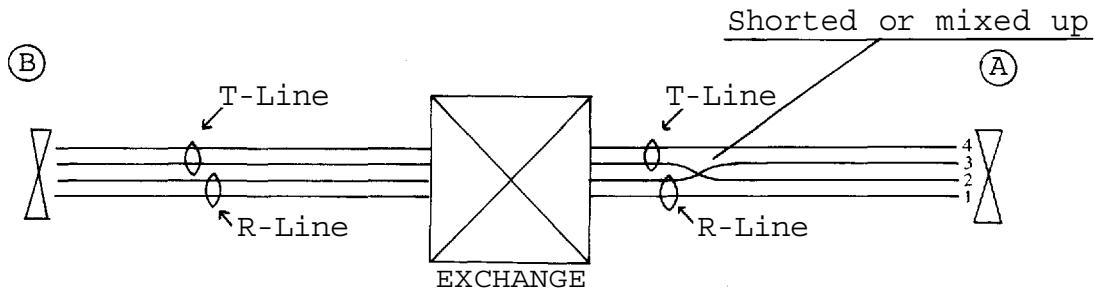

Sympton: 3-1 A can not dial.  
 3-2 Conversation is impossible between stations.  
 3-3 When B dials A , noise will be heard at B immediately after the calling tone.

LMU Lamps ----- Brighter than normal.

4. T-Line and R-Line are connected conversely.

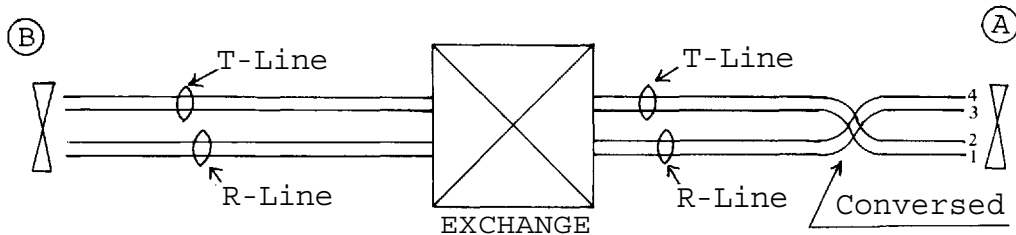

Sympton: 4-1 A can not make dialing.  
 4-2 Conversation is impossible between stations.  
 4-3 When B dials A , noise will be heard at B.

LMU Lamps ----- Brighter than normal.

8-3. FAULT IN SPECIFIC STATION ONLY

Find the cause according to the following table if the fault lies with a specific station only, not with all stations.

	CHECK-ITEM	CAUSE
Dialing can not be made at privacy off mode.	LMU Lamp is off.	* Disconnection of both T & R-Lines. * Guard resistor 330 ft on LMU is burned out due to T & R-Lines short.
	Specific Lamp on LMU is brighter than normal.	* T & R-Lines are shorted.
	LMU Lamp is on in normal.	* Fault in the station. (Replace PCB board.)
Specific key does not operate.	Replace the station and make sure that the station is not faulty.	* Fault in key board switch or matrix circuitry. * Fault in the dial generator. (Replace PCB board.)
Calling tone can not be heard.  Dialing tone can not be heard on dialing.  Sound from the other party can not be heard.	Same symptom remains even if the station is replaced.	* Short or open in R-Line. * Fault in the demodulation circuitry on LMU. (Check LM-380, MT-547.)
	Becomes normal if the station is replaced.	* Disconnection of R-Line or improper connection of the station connector. * Fault in MT-547 on LMU. * Station fault.
Sound is not transmitted to the other party.	Same symptom remains even the station is replaced.	* Short or open in T-Line. * Fault in the modulation circuitry on LMU.
	Becomes normal if the station is replaced.	* Fault in MIC circuitry of the station. (Replace MIC or PCB)
On dialing, noise is heard by the called party.	Same symptom remains even the station is replaced.	* One of T-Lines is disconnected.
	Becomes normal if the station is replaced.	* Fault in MIC element. * Fault in T-Line of the station. * Low frequency oscillation of MIC AMP. (Faulty bypass capacitor)

<p>Sound of the other party is broken during call.</p>	<p>Same symptom remains even the station is replaced.</p>	<ul style="list-style-type: none"> <li>* Adjust the volume control of station speaker if the room produces reverberation. (Lower the volume.)</li> <li>* Increase the gain of MIC AMP.</li> <li>* Replace PCB after checking if MIC unit is not touching its case.</li> </ul>
<p>Immediately after the calling tone, the line switches to cancel, busy, dial tone, etc.</p>	<p>Same symptom remains even the station is replaced.</p>	<ul style="list-style-type: none"> <li>* One of R-Lines is disconnected.</li> <li>* Fault in photo coupler PC-504 on LMU.</li> <li>* Fault in MT-547 on LMU or in the station.</li> </ul>
	<p>Becomes normal if the station is replaced.</p>	<ul style="list-style-type: none"> <li>* One of the R-Lines is disconnected or the station connector is not connected properly.</li> </ul>

#### 8-4. SPEECH AND FUNCTION TEST

##### 1. Speech Test

After completing the wiring check and the power supply and exchange test according to the system flow chart, the speech test for each station can then take place.

##### IMPORTANT NOTE

Before testing, all programming (Secretary transfer, Master/Substation, Executive Priority Function) must be cleared from station No.200 by turning on the PROGRAM switch of the CPU, or the speech test can not proceed correctly.

- \* Call every station one by one from any master station and examine the speech quality and sound volume.
- \* The sound volume can be adjusted by the volume on the rear of the station. (Fully clockwise for maximum)
- \* A call to a station in the room produces reverberation and may present broken sound. Turn down the volume of the station speaker until the sound becomes normal.
- \* Each station must be located properly where no feedback will occur between station and external speakers. The gain adjustment of the paging amplifier is also important in order to avoid troublesome feedback.
- \* The Press-To-Talk bar on the station keyboard must be used for the speech test when stations are installed in high noise areas (more than 60dB noise).
- \* Speech quality (broken sound, natural conversation, tone quality, etc.) must be tested with each line in the CLU or DLU employed in the system.

## 2. Function Test

- \* Check all employed functions with a few stations near the exchange.
- \* Check "User Programmable Functions" at stations involved after the programming from station 200.
  - + Secretary Transfer: Is transfer made correctly with the privacy switch on at the executive station.
  - + Master/Substation : Touch dial  at substation can call its master station.
  - + Executive Priority: Is this function operated at stations involved.
- \* Use all number keys including  and  , Press-To-Talk bar, Vol. L/H and privacy switch to test all functions.

EXAMPLE: + Both calling and conversation tests with station number 200 through 209.

- + Change the position of Vol. L/H and make sure that the switch works.
- + Turn the privacy switch ON. Is privacy tone heard from the station when someone calls?

---

# MEMO

---

---



---

# MEMO

---

---



**TOA ELECTRIC CO., LTD.**  
KOBE, JAPAN