

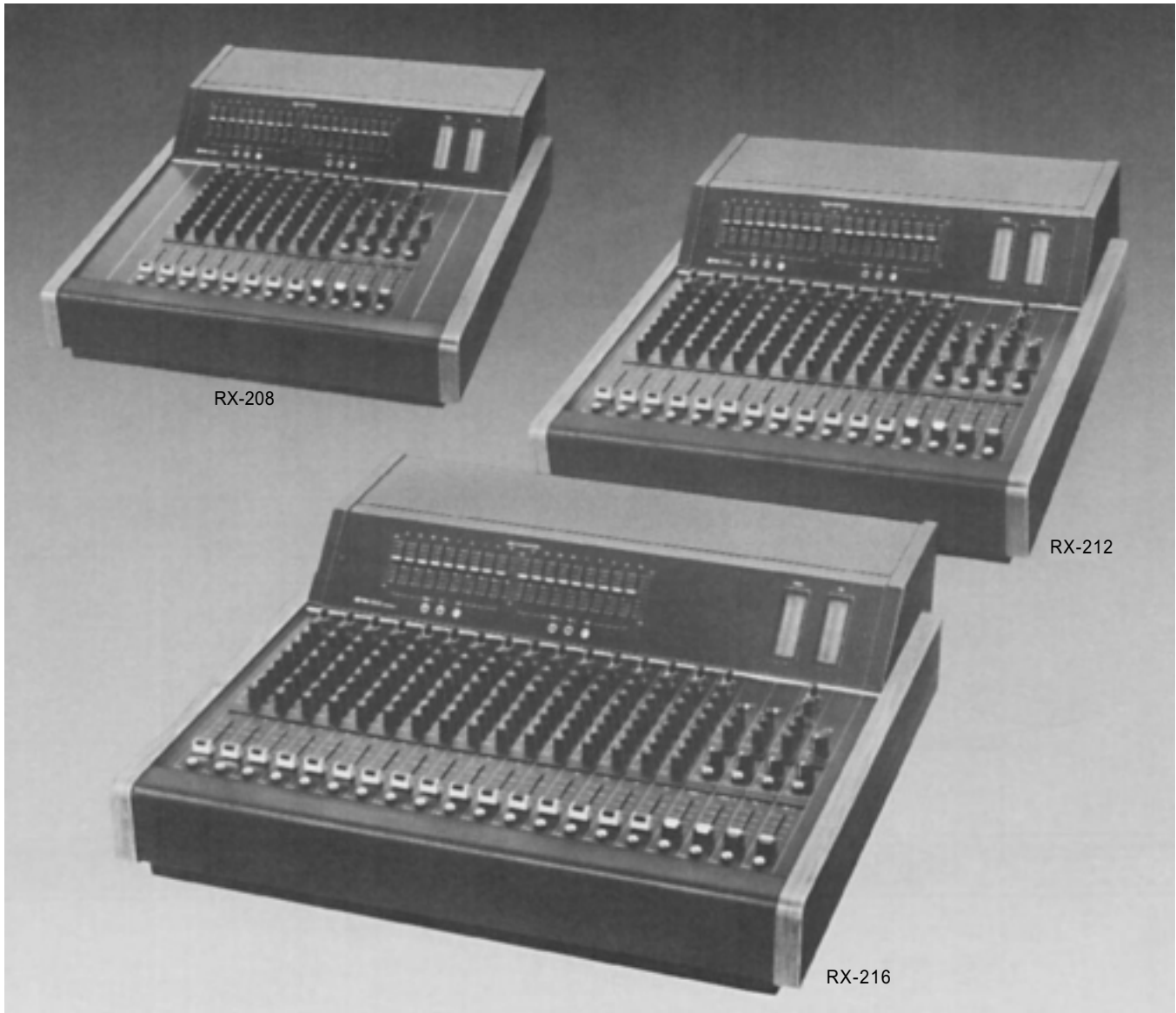

TOA MIXING CONSOLE

Model RX-208, RX-212, RX-216



TOA ELECTRIC CO, LTD
KOBE, JAPAN

Contents

General Description	2
Features	2
Front Panel, Input Section	3
Front Panel, Output Section	4
Meter Panel	5
Rear Panel (RX-208)	6
Rear Panel (RX-212, RX-216)	7
Connection Examples	8~10
How to use "channel patching" accessory jack	11
How to get a good mixing	12
Channel and Graphic Equalizers	13~14
General Specification	14
Input & Output Specifications	15
Characteristic Diagrams	16
Block Diagram	17
Level Diagram	18
Dimensional Diagrams	18

Precautions

1. Each model of the RX-208, RX-212 and RX-216 has two versions, 120V AC operation only and 220/240V AC operation with a voltage selector. The voltage selector on the rear panel of the 220/240V version should be checked for proper setting prior to operation as improper setting causes trouble. The voltage selector is set for 240V operation at the factory.



2. **Power Switch**
The power switch should be on after all connections have been completed.
3. **XLR (Cannon) Connectors**
The connectors are wired in the following manner: Pin 1 is ground (shield); pin 2 is cold (low, minus); pin 3 is hot (high, plus).
4. **Description of components and functions on the RX-208, RX-212 and RX-216.**
In our Operating and Instruction Manual explanation of components and functions is made according to our usage for them.

General Description

The RX-208, 212 and 216, are mixing consoles with 8, 12 and 16 inputs respectively, 2 program outputs, 2 foldback outputs, and 1 echo output. Each input channel and line output has a balanced, low impedance, transformer-isolated, XLR connector, and an unbalanced, 1/4" jack. Each input channel includes an accessory send/receive jack for inserting a signal processing device into the signal path, and a phantom power ON/OFF switch for permitting use of a condenser microphone. An input level switch and trim control on each input channel are provided to permit optimum settings. A four-band equalizer is included on each input channel. A peak indicator LED on each input detects excessive inputs and helps avoid clipping. A pan control on each input channel assigns the fader output signal of the channel to programs L and R. A cue switch on each input channel, stereo input, aux/echo input, program output, foldback output and echo send allows monitoring the respective, pre-fader (pre-volume) signals through the phones output. All faders are log-linear type with 60mm of travel. Additional stereo inputs are used to connect a stereo playback deck, disk player and other auxiliary equipment. Two independent foldback outputs are included, (pre-fader, pre-EQ) signals. An analog, electronic echo is built in, but can be bypassed (via Echo Send/Return for external delay, reverb or special effects). Dual Graphic Equalizers (1/1 octave, 9 bands) are switchable to either the program outputs or foldback outputs. A fluorescent bargraph peak meter (2-color, vertical type) monitors the outputs of the programs L and R, and foldbacks 1 and 2. These consoles are designed for use in professional sound reinforcement systems, and provide versatile functions to meet a wide range of requirements. The high performance and modular construction assures reliability, easy maintenance, and serviceability.

Features

1. Balanced, low impedance, (transformer-isolated) XLR connector with an unbalanced 1/4" jack on each input channel and line input.
2. An accessory send/receive jack on each input channel.
3. A phantom power switch on each input channel.
4. Input level switch and trim control on each input channel.
5. Four-band equalizer on each input channel.
6. Peak indicator LED on each input channel.
7. Cue switch on each input channel, stereo input, aux/echo input, program output, foldback output and echo send.
8. All faders are log-linear type with 60mm travel.
9. Built-in, electronic analog echo unit.
10. Dual graphic equalizers (1/1 octave, 9 bands) are switchable to either the program or foldback outputs.
11. Additional, stereo inputs for connecting a stereo playback deck, disk player and other auxiliary equipment.
12. Fluorescent bargraph peak meters for monitoring the programs L and R, and foldbacks 1 and 2.

Front Panel, Input Section

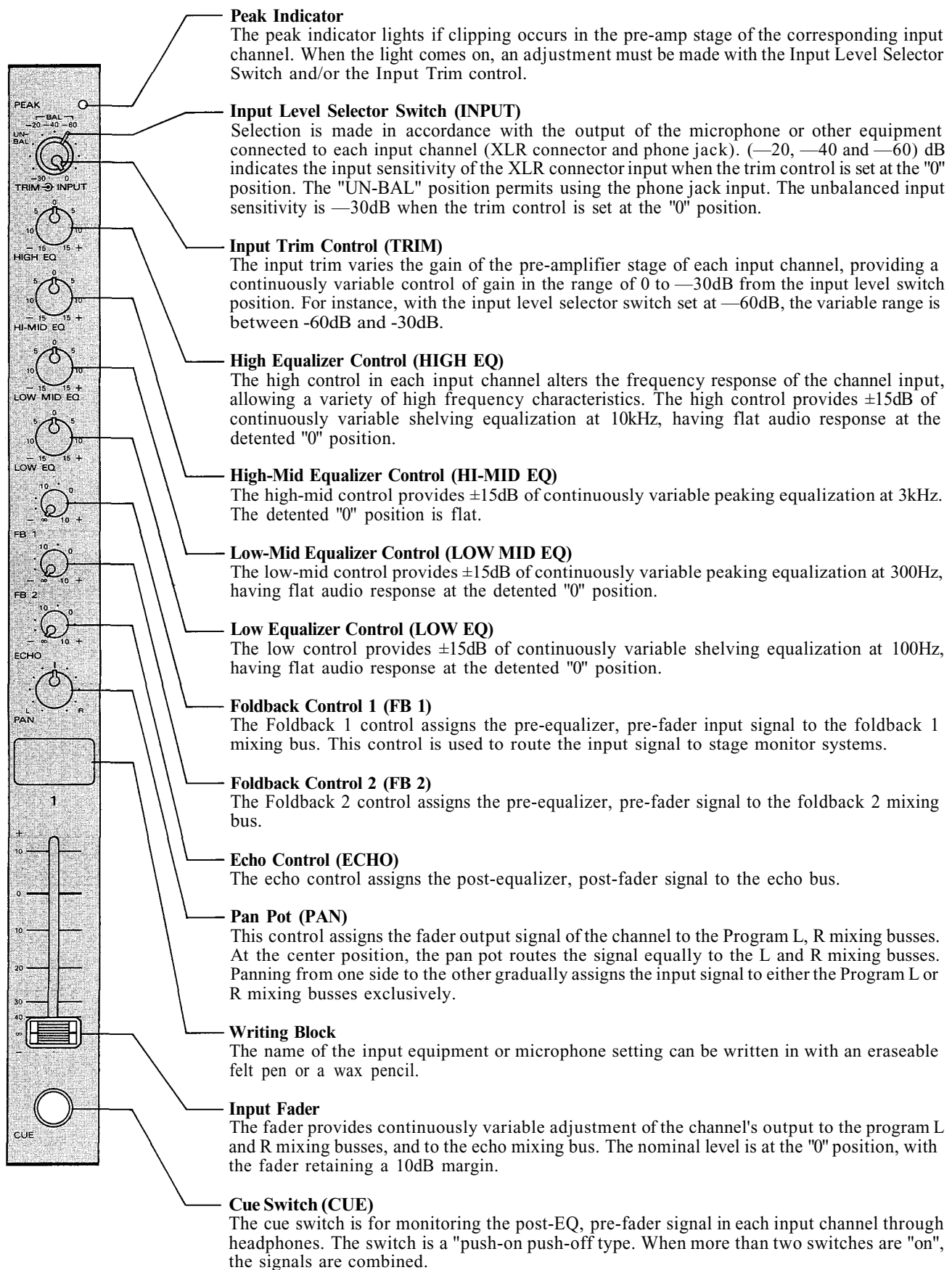

Front Panel, Output Section

FB 1 Volume Control (FB1)
This control attenuates the echo-return signals from the built-in echo or an external echo unit and assigns them to the FB 1 mixing bus.

FB 2 Volume Control (FB2)
This control attenuates the echo-return signals from the built-in echo or an external echo unit and assigns them to the FB 2 mixing bus.

Stereo Input Switches (INPUT)
Each switch has two positions, aux and phono. The aux position accepts line level signals such as tape recorders. The phono position provides direct input and RIAA equalization for a turntable.

FB 1 Volume Control (FB1)
This control attenuates the stereo input signals, mixes them to a monaural signal, and assigns them to the FB 1 mixing bus.

FB2 Volume Control (FB2)
This control attenuates the stereo input signals, mixes them to a monaural signal, and assigns them to the FB 2 mixing bus.

Balance Control (BALANCE)
This control adjusts the level balance of the stereo input signals fed to the program L & R mixing busses.

Writing Block
The name of the input equipment can be written in with an erasable felt pen or a wax pencil.

Stereo Input Volume Controls (STEREO 1, STEREO 2)
These controls adjust the level of the stereo in 1 and 2 signals to be fed to the program L and R mixing busses.

Cue Switch (CUE)
The cue switch is for monitoring the pre-fader signal in each stereo input channel through headphone. This feature is useful for cueing the start of a tape or record.

Writing Block
The name of the input equipment or microphone setting can be written in with an erasable felt pen or a wax pencil.

Program Fader L and R (PGM L, PGM R)
The program faders control the overall signal level of the program mixes which are fed to the program L & R outputs, and thus the output level of the assigned internal power amplifier.

CueSwitches (CUE)
The cue switch is for monitoring the pre-fader program signals through headphone. This is useful for independent audition of the program mixes.

Echo Time Control (T1 DELAY)
This control permits continuously variable adjustment of the echo time in either short or long ranges. The short range is from 14m to 40m seconds; the long range is from 40m to 140m seconds.

Echo Time Switch (SHORT, LONG)
The switch changes the echo time to either the short or the long range.

Regeneration Control (T2 REGEN)
The T2 control is provided to adjust the echo pattern (number of repeats) of the internal analog delay.

Headphone Jack
The headphone jack will accept any stereo headphone with 8 ohms impedance, or higher.

Phones Level Control (PHONES)
The phones level control adjusts both the program L and R signals fed to the phones output and permits stereo monitoring when the cue switch is off. When the cue switch is on, the control adjusts the corresponding cue signal. When two or more of the cue switches are on, the control adjusts the corresponding combined cue signals.

Pan Pot (PAN)
The pan pot control assigns the signals from the built-in echo or external echo unit to the program L and R.

Echo Return Volume Control (ECHO RETURN)
This control sets the signal level from the built-in echo or from an external echo unit and sends it (through the pan control) to the program L and R.

Echo Send Volume Control (ECHO SEND)
This control is provided to adjust the overall signal level of the echo mix to the echo send output, or to the internal analog delay.

Cue Switch (CUE)
The cue switch is used for monitoring the signal prior to the Echo/Send volume control.

Cue Switch (CUE)
The cue switch is used for monitoring the signal prior to the Echo/Return volume control.

FB Fader 1 and 2 (FB1, FB2)
These faders control the overall signal level of the mixes which are fed to FB outputs 1 and 2.

Cue Switch (CUE)
The cue switch is used for monitoring the signals prior to the FB 1 and 2 outputs.

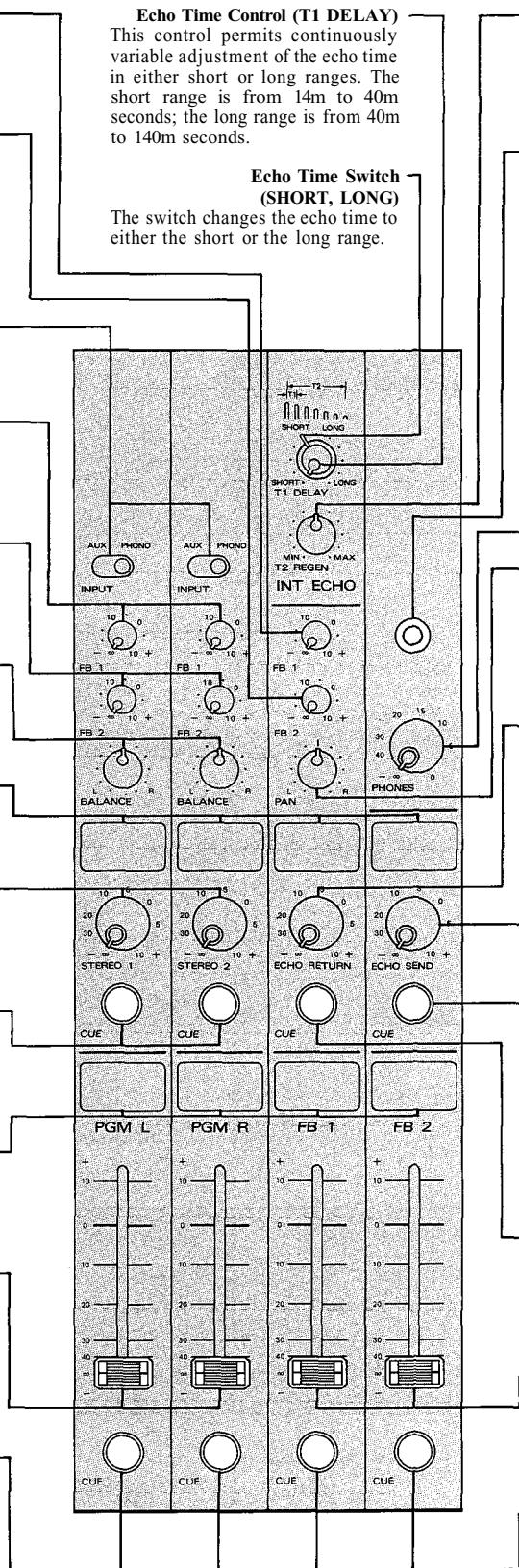

Meter Panel

RX-208, RX-212

Graphic Equalizer (EQUALIZATION)

Two channel, 1/1 octave graphic equalizer with 9 bands (filters) enables 12dB of boost and attenuation at each center frequency with the "0" position of each filter providing flat response. The graphic equalizer is switchable to either the program or foldback outputs, or "off for A-B comparison.

Program L Output Meter (PGM L)
The meter indicates the program L output level.

Program R Output Meter (PGM R)
The meter indicates the program R output level.

FB 1 Output Meter (FB 1)
The meter indicates the FB 1 output level.

FB 2 Output Meter (FB 2)
The meter indicates the FB 2 output level.

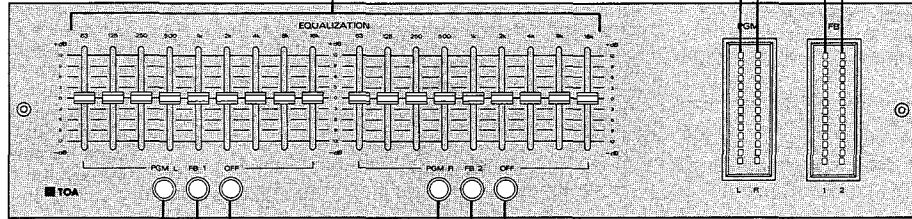

Graphic Equalizer Selector Switch (PGM L, FB 1, OFF)

The 3-position switch assigns the equalizer to either the program L or FB 1 circuits, with the "off" position completely removing the equalizer from the signal flow path.

Graphic Equalizer Selector Switch (PGM R, FB 2, OFF)

The 3-position switch assigns the equalizer to either the program R or FB 2 circuits, with the "off" position completely removing the equalizer from the signal flow path.

Caution

The graphic equalizer is normally used for either the PGM or FB mix. For normal operation, only one button should be pressed. If the equalizer is not being used, the "OFF" button should be depressed.

RX-216

*The RX-216 is the same in its meter panel functions as the RX-208 and RX-212.

Graphic Equalizer (EQUALIZATION)

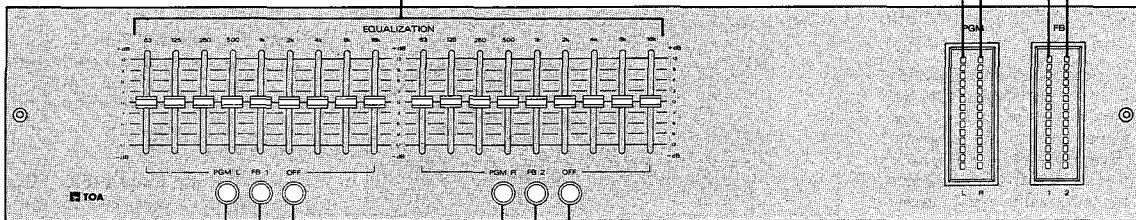

FB 2 Output Meter

FB 1 Output Meter

Program R Output Meter

Program L Output Meter

Graphic Equalizer Selector Switch (PGM L, FB 1, off)

Graphic Equalizer Selector Switch (PGM R, FB 2, off)

Rear Panel (RX-208)

RX-208

Program Line Output Connectors and Jacks (LINE OUT, PGML, R)

These connectors and jacks are the outputs of the console deriving the signals after each program master fader. The XLR connectors are balanced, transformer-isolated, floating, with an output impedance and nominal level of 600 ohms and +4dB, respectively. The phone jacks are unbalanced, with an output impedance and nominal level of 600 ohms and +4dB, respectively.

Power Switch (POWER)

This switch provides AC power to the console. Power should only be applied after all audio connections have been completed.

Power Fuse

Phantom Power Switches (PHANTOM 1-8)

The phantom power switch on each input channel permits the user to supply 48V DC through the input connectors to a condenser microphone. If phantom power is not required, the switch must be in the "off" position.

Accessory Send/Receive Jacks (ACCESSORY 1-8)

These jacks are provided as patching points for inserting signal processing equipment such as compressor/limiters, noise gate, etc. An output impedance of the accessory send and an input impedance of the accessory receive are 10k ohms. Both nominal signals levels are 0dB. Please refer to the detailed explanation on page 11.

Channel Input, Unbalanced Jacks (CHANNEL IN UN-BAL 1-8)

These 8 standard 1/4" phone jacks are unbalanced with an input level of -30dB and input impedance of 10k ohms. They will accept low or high impedance sources. When plugs are inserted into these jacks, the input level switch must be set to the "UN-BAL" position.

Channel Input, Balanced Connectors (CHANNEL IN BAL 1-8)

The XLR connectors are balanced, transformer-isolated, floating, with an input impedance of 600 ohms, and will accept low impedance microphones as well as other impedance sources. When the XLR connectors are employed, the input level switch on the front panel must be set at the "BAL" positions. Proper adjustment of both input level switch and trim control make it possible to provide the optimum setting for each input.

Power Cord

Ground Terminal (GND)

The chassis must be grounded.

Foldback Line Output Connectors and Jacks (LINE OUT FB 1, 2)

These connectors and jacks are the foldback outputs deriving the signals after each foldback master fader. The XLR connectors are balanced, transformer-isolated, floating, with an output impedance and nominal level of 600 ohms and +4dB, respectively. The phone jacks are unbalanced, with an output impedance and nominal level of 600 ohms and +4dB, respectively.

Echo Output Jacks (ECHO SEND)

These jacks are unbalanced, with an output impedance of 600 ohms. One jack is for +4dB output and the other is for -20dB output. The jacks are provided for connection to external echo machines. The +4dB jack can be used for output cascading.

Sub Input Jacks (SUB IN PGML, R, FB 1, 2, ECHO)

These five jacks are directly connected to the corresponding mixing busses (program L, R, FB1, 2, and echo), and are provided for cascade connection to expand the input capacity.

Ground Terminals (GND)

These may be used to provide ground connection for tape decks or turntables.

Stereo Input Pin Jacks (STEREO IN 1, 2)

Each stereo input has both AUX input and PHONO input pin jacks that are switchable on the front panel. RIAA equalization is provided on the phono input for accepting turntables with magnetic cartridges.

Recording Output Pin Jacks (REC OUT, PGML, R)

The jacks are unbalanced and provide pre-graphic EQ, pre-program fader signals for connection to tape recorders.

Auxiliary Echo Input Jack (AUX ECHO IN)

This standard phone jack is unbalanced and accepts low or high impedance sources at nominal -20dB level. The jack sends an echo or reverb return signal directly to the program L and R mixing busses. Inserting a plug in the jack interrupts the return signal from the built-in echo unit. The echo or reverb return signal can be controlled by the echo return volume on the front panel.

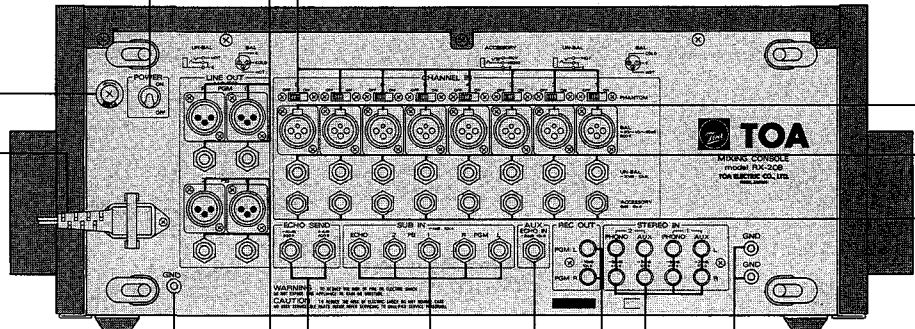

Rear Panel (RX-212, RX-216)

The RX-212 and RX-216 are the same as the RX-208 in functions, except that the RX-212 has 12 input channels and the RX-216 has 16 input channels.

RX-212

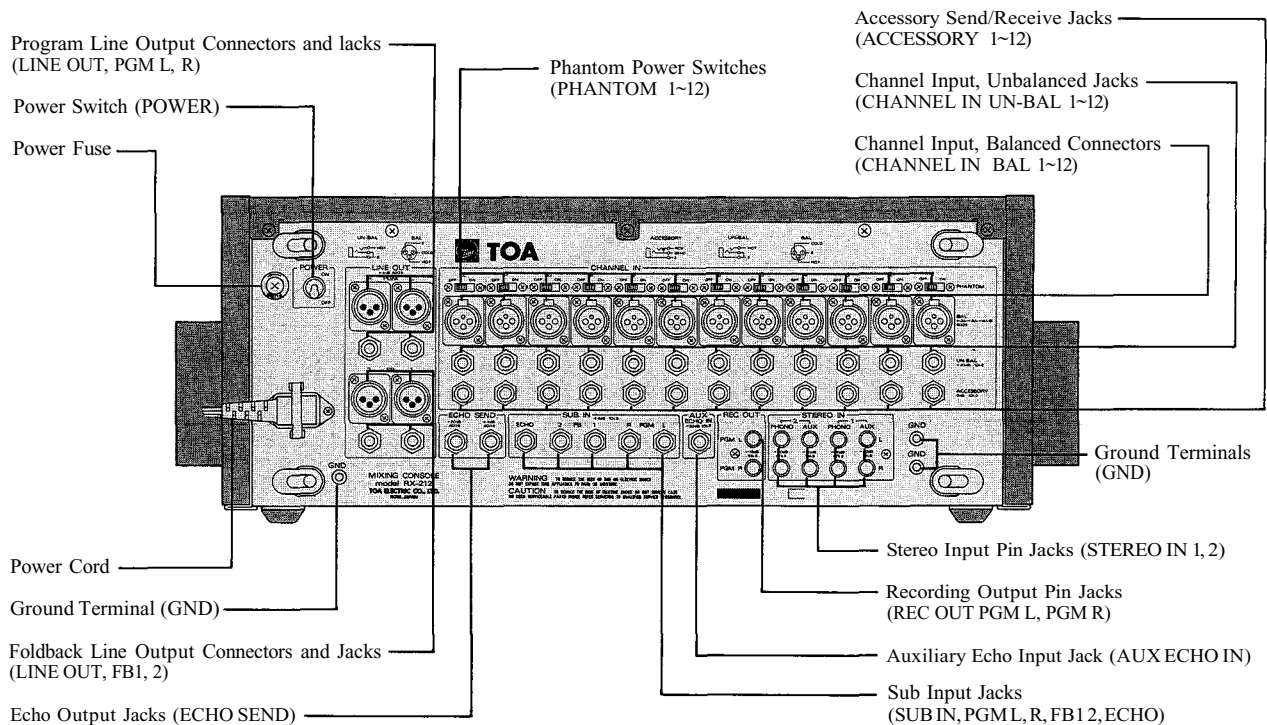

RX-216

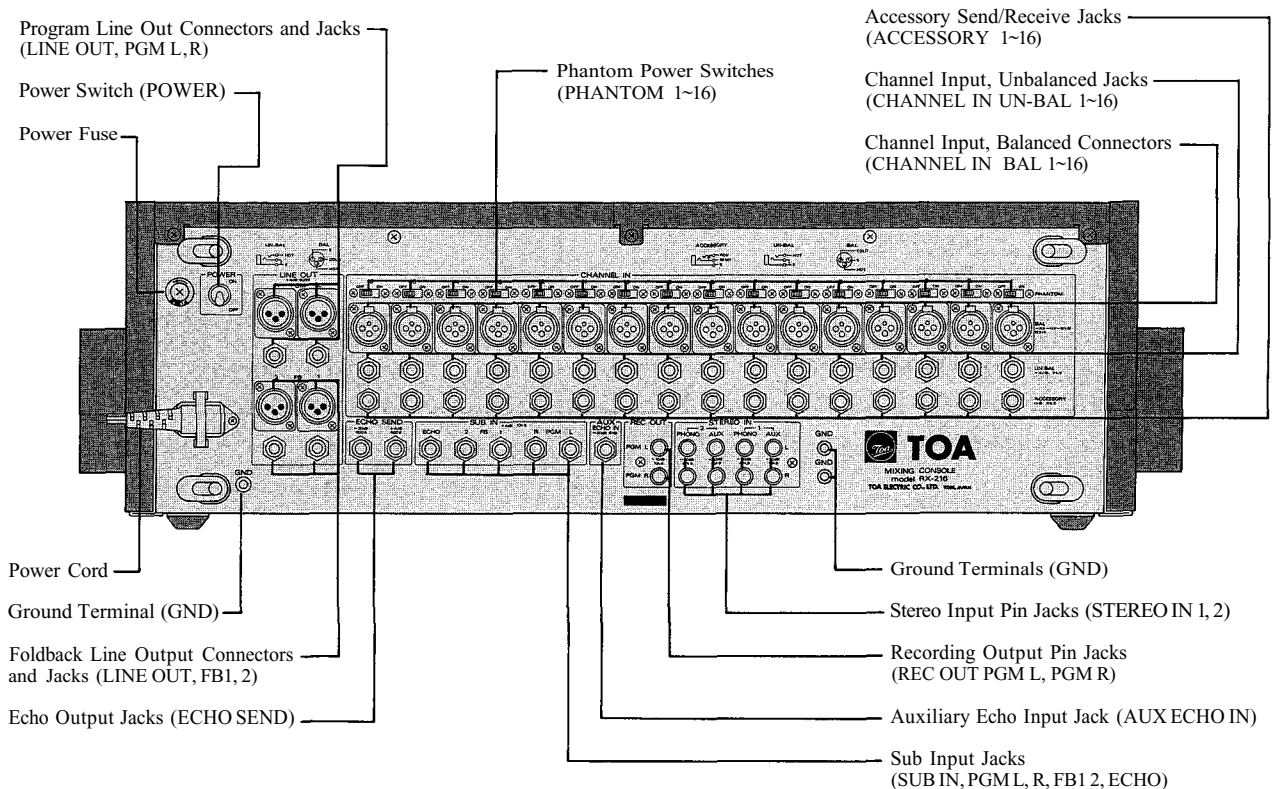

Connection Example

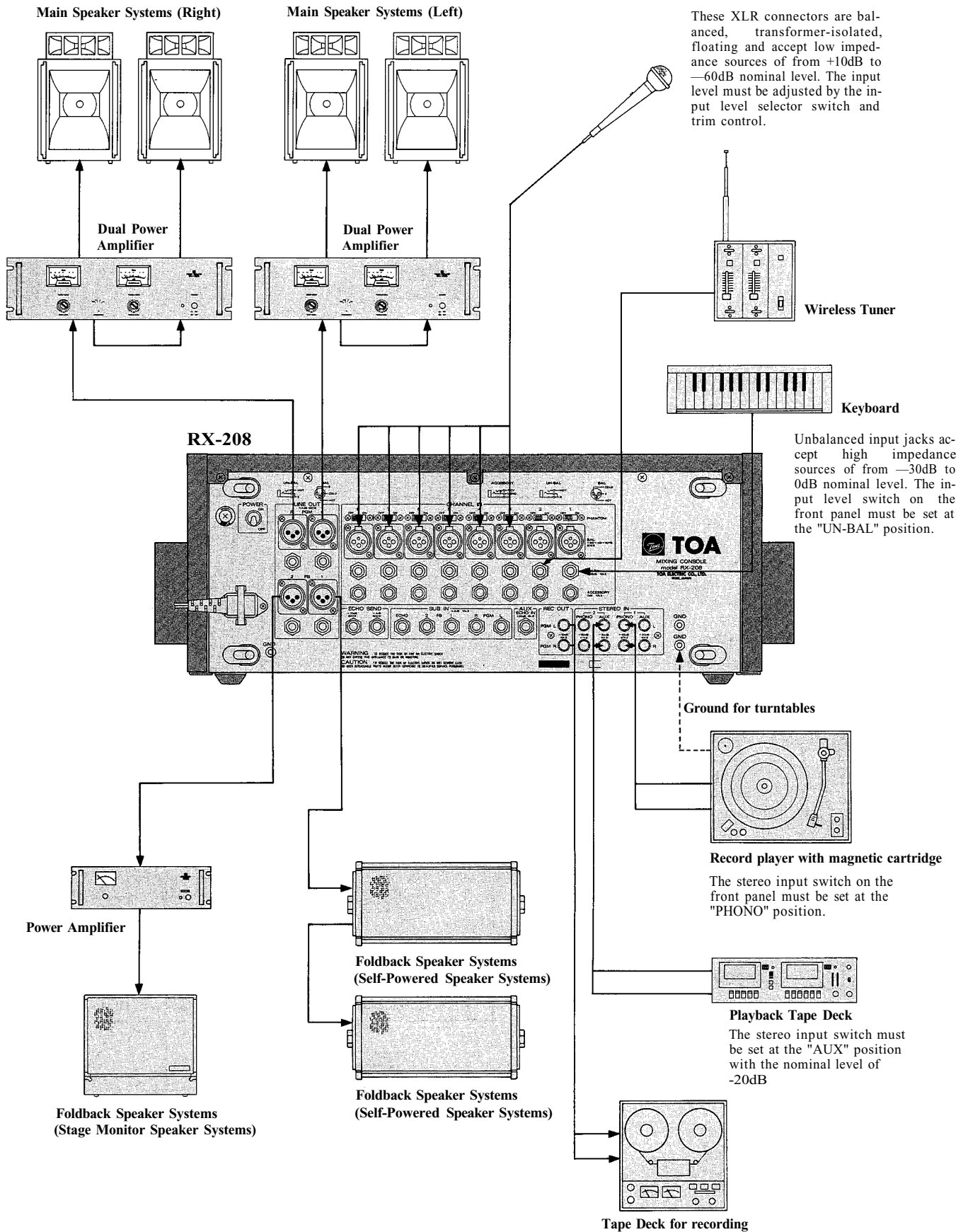

These XLR connectors are balanced, transformer-isolated, floating and accept low impedance sources of from +10dB to -60dB nominal level. The input level must be adjusted by the input level selector switch and trim control.

Unbalanced input jacks accept high impedance sources of from -30dB to 0dB nominal level. The input level switch on the front panel must be set at the "UN-BAL" position.

The stereo input switch on the front panel must be set at the "PHONO" position.

The stereo input switch must be set at the "AUX" position with the nominal level of -20dB

Connection Example

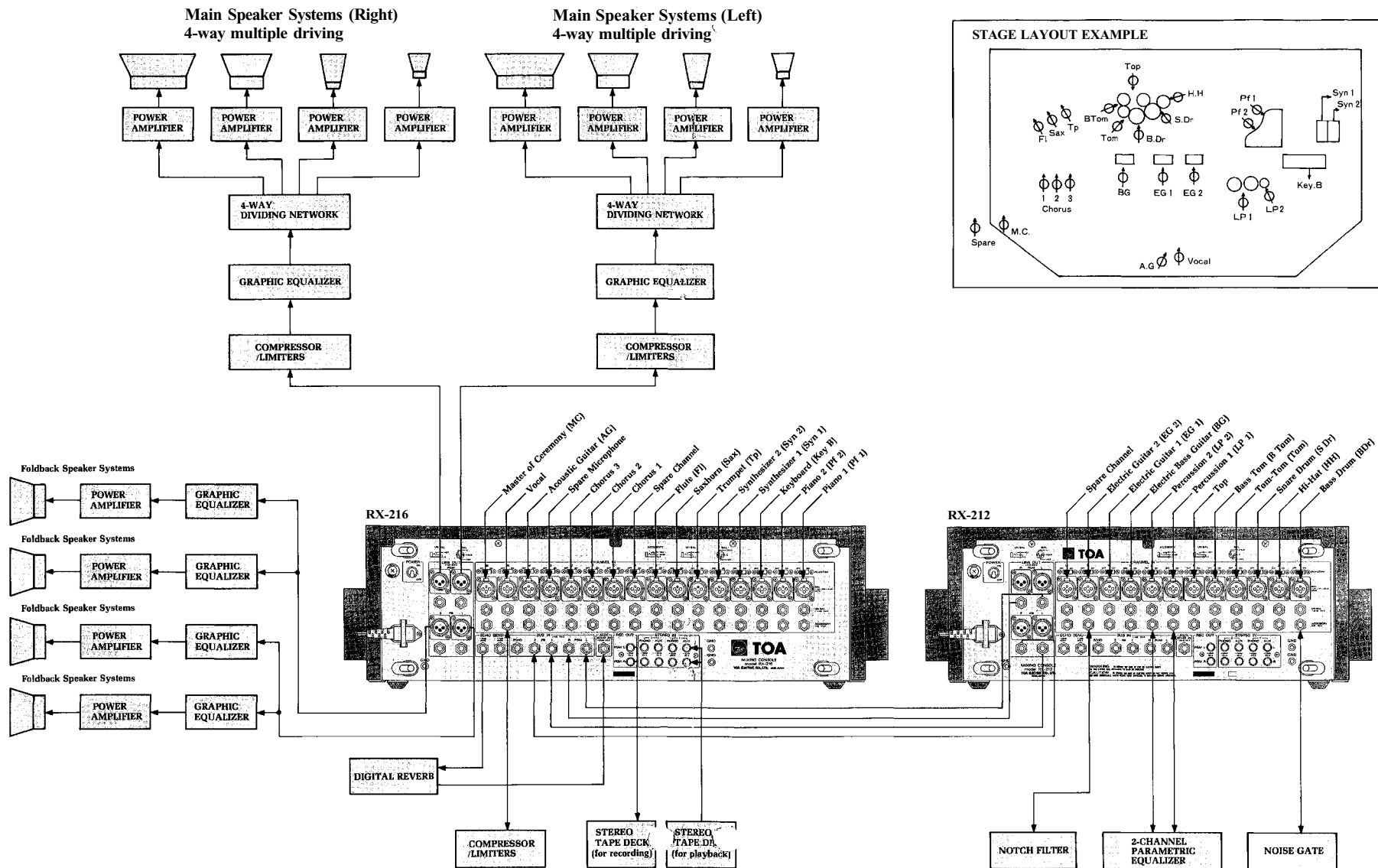

How to use "channel patching" accessory jack

The accessory jack (Tip, Ring, Sleeve) is provided on each input channel to allow insertion of outboard signal processing devices (example: compressor/limiters, noise gate, equalizer, etc.) into the signal path. The jack functions as both an output and an input (Tip=Receive, Ring=Send, Sleeve=Shield). Connection cables for this purpose should be wired as illustrated in Fig. 2.

Inserting a plug into the jack interrupts normal signal flow and places the external device into the circuitry just prior to the input equalizer section. (See Fig. 1.)

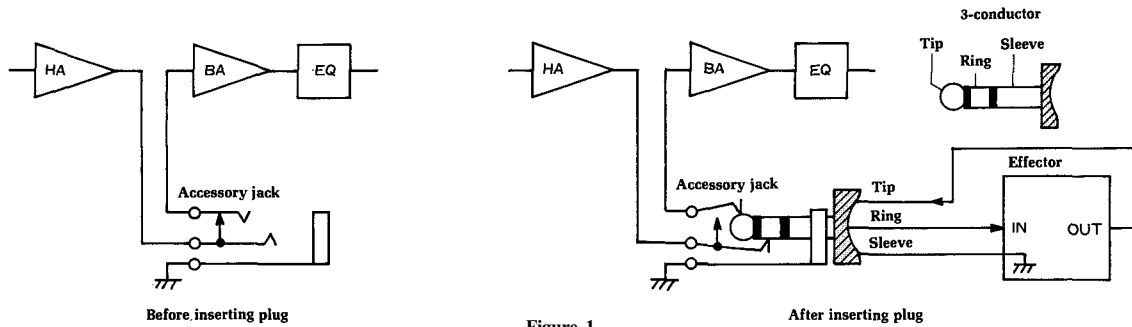
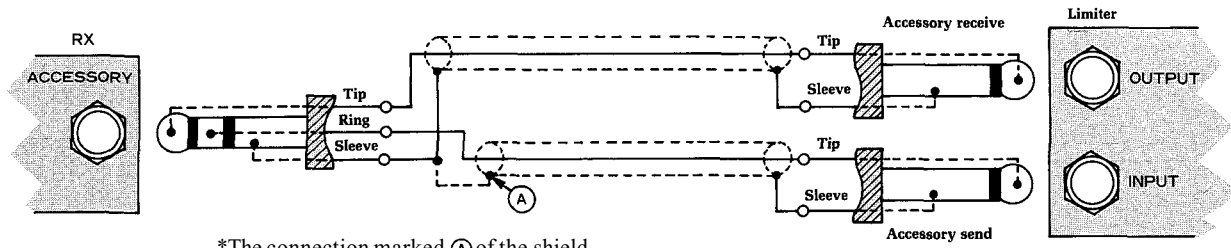

Figure 1



*The connection marked (A) of the shield and sleeve is determined by the type of equipment to be connected.

Figure 2

The accessory jacks may also be used as a direct output for each input channel, allowing direct connection to a multi-track tape deck or use as an additional effects mix.

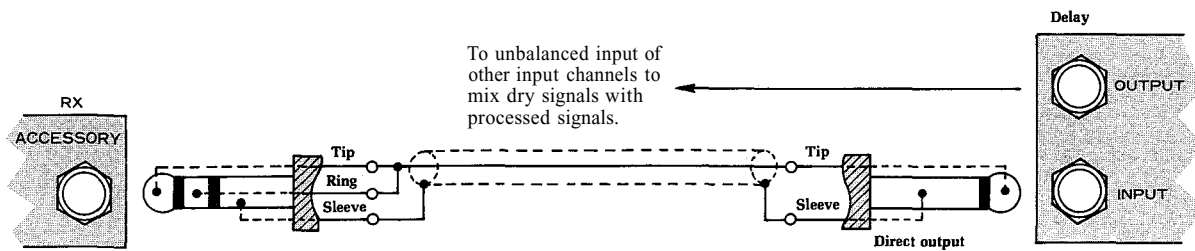
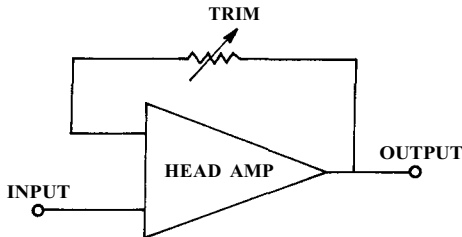

Figure 3

Normal impedance of the accessory send is greater than 10k ohms and the receive impedance is 10k ohms. Both nominal levels are at 0dB (0.775V).

How to get a good mixing

- Before connecting the equipment to the mixing console, check the impedance and level of both. If the impedances and levels do not match, mixing will be very difficult and the S/N ratio will also be adversely affected.
- Each input channel of the RX-208, RX-212 and RX-216 is provided with a Trim control. Thorough understanding of the function of a Trim control will make mixing easier.



- The function of the Trim control is that the negative feedback volume of the head amp is changed so that the gain of the head amp can also be changed. Because of this, enough dynamic range even for the high level signals is ensured. Also, S/N ratio will be better by decreasing the gain of the head amp proper.

For example, a microphone (balanced) with an output level of -50dB , a tape deck (balanced) with an output level of 0dB , and a wireless tuner with an output level of -20dB are connected to the console.

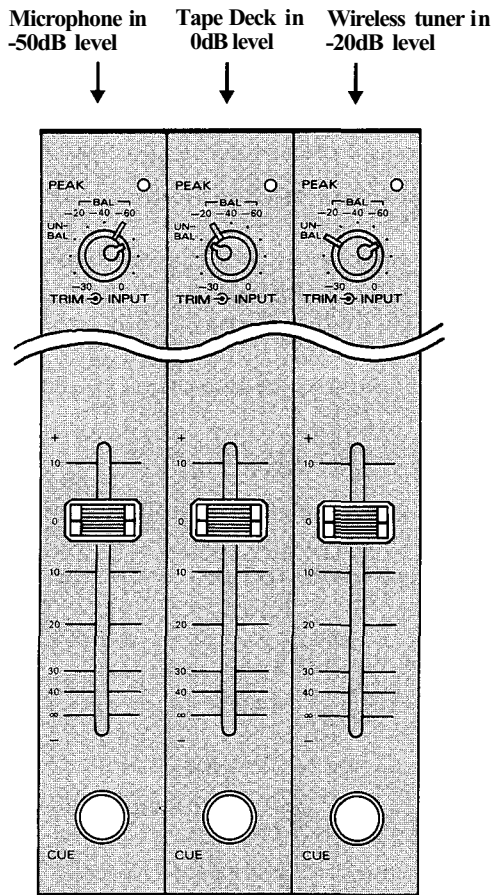

First the Trim control must be turned down so that the peak indicator will not be lit if an excessive signal comes in. Nevertheless, if it is still on, the input level switch must be rotated to the left 1 step. This can be applied to the "BAL" inputs only, not to the "UN-BAL" inputs.

The input selector switch is set as shown in the left figure. Trim control is set as shown in the left figure. Also, if the volume balance of each instrument (microphone) is kept by the Trim control the position of each channel fader will be uniform, thus mixing becomes easier.

The faders in each channel are used in general between 0 and 10. If the hall is full and there is not enough volume, the master fader must be turned up.

Channel and Graphic Equalizers

Equalization for music

The Graphic Equalizer is designed not only for use in preventing feedback and equalizing uneven room frequency response to be flat, but also for equalizing frequency response to your tastes and producing favourable sound for you. Fig. 1 shows each frequency band and its corresponding auditory feeling. Fig. 2 and Table 1 show the relation between each musical instrument and its frequency band. They can be of great help in the equalizer operation. (They are referenced from a book entitled "Practical Guide for Concert".)

EQUALIZATION CHART

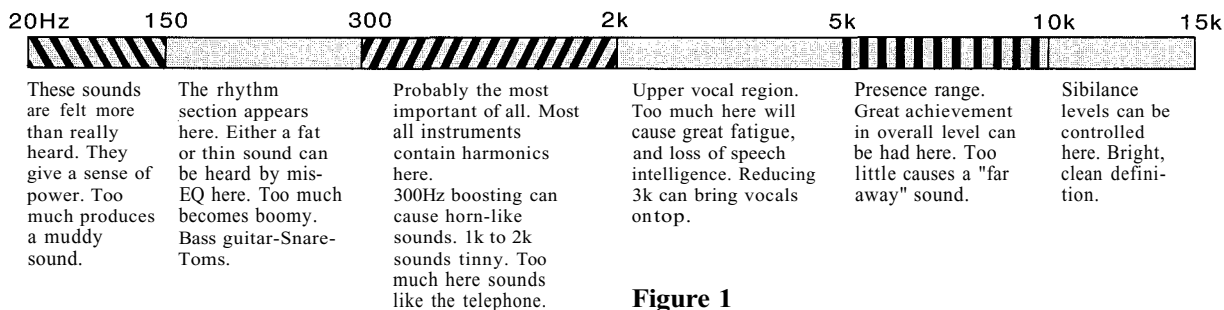

Figure 1

INSTRUMENT CHART

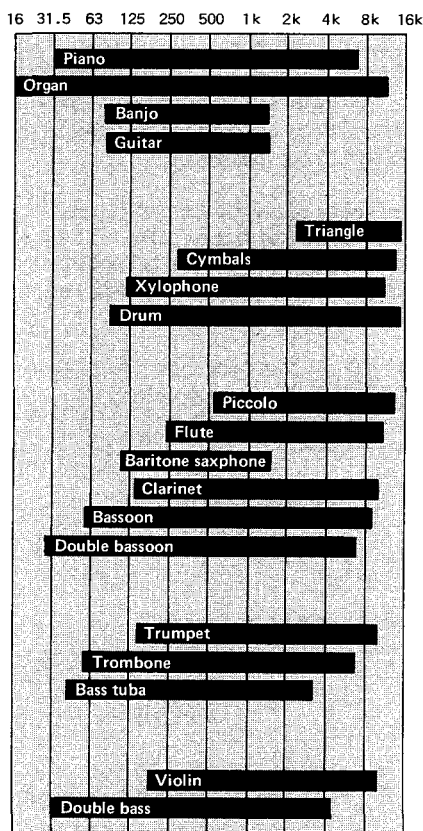
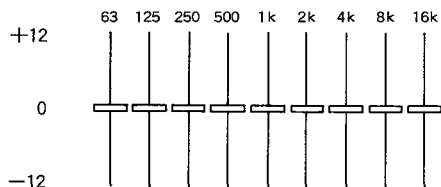

Figure 2

INSTRUMENT EQUALIZATION CHART

Acoustic guitar	Bass strings resonate between 70 to 120Hz, body around 300Hz. Avoid boosting these to stop feedback. 3kHz and 5kHz give great "clarity".
Electric guitar	Resonances differ—depending on type. Good full sounds around 300 to 500Hz. Clarity at 3kHz.
Bass guitar	Extreme lows are at 60 to 90Hz. "Pick" or "pluck" sounds are around 800 to 1200Hz. Upper harmonics clarified about 3kHz.
Human voice	Good fullness at 150Hz. Watch for "boominess" around 250Hz. Mid-range 10kHz.
Piano (Acoustic)	Bass strings resonate around 100Hz. Watch for sub-harmonics at 30 to 50Hz.
Piano (Electric)	Good mid-clarity at 3kHz to 5kHz thins out rapidly in high end. Be careful around 1.5kHz to 2.5kHz to avoid the "bar room sound."
Organ	Usually dies under 200Hz. Has great mid-sounds around 1200 to 2000Hz. Top end cuts off at 6kHz.
Violin	Rich fullness at 400Hz. Natural raids around 1500 to 2500Hz. Avoid "scratch" sounds at 8kHz.
Brass instruments	Watch for "hot" mids around 2kHz. Low end boost around 400Hz. Top end clarity at 6kHz.
Bass drum	Great low "kick" at 40Hz. The mids at 2kHz gives the familiar "punch."
Snare drum	Good fullness at 100Hz. The "crack" is boosted at 2kHz. The snares extend to above 4kHz.
Tom Tom	The main fullness is around 200Hz. The mid punch extends to 4kHz.
Floor Tom	Same as tom, but extends down to 80Hz.
Hi Hat	Watch for the "gong" sound around 300Hz. Good "shimmer" sounds are around 8kHz to 10kHz.
Cymbal overhead	About the same as hi-hat but has more low end around 150Hz.
Talk Box	Depending on the guitar sound driving it and the resonance of each player's mouth, should have great "bite" around 1200Hz and dies above 6kHz.

Table 1

Channel and Graphic Equalizers

Feedback Prevention

When the overall gain of a sound system is increased, feedback will occur at frequencies where the system response has peaks. Suppose the system has uneven frequency response like that shown in the following diagram.

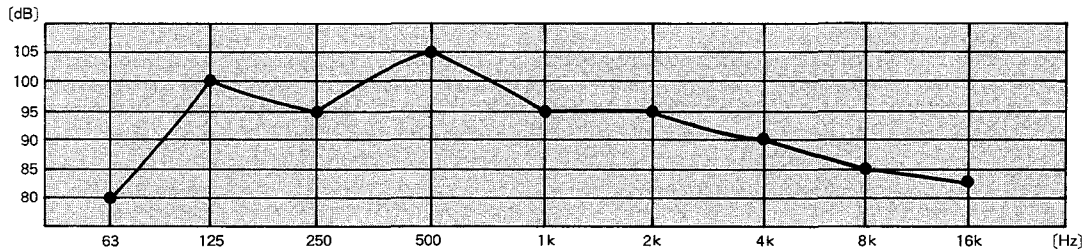

The frequency at which feedback will occur when gain is increased is about 500Hz. In this case, feedback may be prevented by attenuating levels at 500Hz by 3dB to 5dB with an equalizer. If the overall gain is again gradually increased, feedback will occur next at about 125Hz. It may be stopped by attenuating the levels 3dB to 5dB at that frequency. In this procedure, sufficient gain in the sound system is obtained before feedback.

General Specifications

Frequency Response

+0dB, -0.5dB 50Hz to 15kHz
 +0.5dB, -3dB 20Hz to 30 kHz

Total Harmonic Distortion

0.5% at +4dB*/600 ohms at 1kHz

Hum and Noise

(20Hz to 20kHz, input termination of 150 ohms, Input level switch at "BAL -60", Trim at "0", output termination of 600 ohms)

Equivalent Input Noise

-124dB* (20Hz — 20kHz)
 -127dB* (IHF-A weighted)

S/N

64dB; PROGRAM OUT
 (PGM Fader and one Input Fader at nominal level)
 64dB; FB OUT
 (FB Fader and one FB control at nominal level)

Crosstalk

-60dB at 1kHz, input to output

Maximum Voltage Gain

84dB CH IN to PGM LINE OUT
 84dB CH IN to FB LINE OUT
 94dB CH IN to ECHO SEND
 60dB CH IN to REC OUT
 60dB CH IN to ACCESSORY SEND
 44dB STEREO IN (AUX) to PGM LINE OUT
 74dB STEREO IN (PHONO) to PGM LINE OUT
 44dB AUX ECHO IN to PGM LINE OUT
 24dB ACCESSORY RCV to PGM LINE OUT
 10dB SUB IN to LINE OUT

Channel Equalizer (±15dB maximum)

LOW 100Hz Shelving
 LOW MID 300Hz Peaking
 HI-MID 3kHz Peaking
 HIGH 10kHz Shelving

Graphic Equalizer (±12dB maximum)

Center Frequency
 63Hz, 125Hz, 250Hz, 500Hz, 1kHz, 2kHz,
 4kHz, 8kHz, 16kHz

Internal Echo Unit

Delay Time SHORT 12msec—40msec
 LONG 40msec—140msec

Peak Indicator

LED turns on when the pre-fader, post EQ signal reaches 6 dB before clip.

Phantom Power

48V DC is applied to balanced input transformer for powering condenser microphones

Meter ("0" = +4dB* output at LINE OUT)

2 pairs of fluorescent bargraph meter for PGM L, R and FB 1, 2.

AC Line Voltage

AC Mains 50 Hz or 60 Hz

Power Consumption

RX-208 44W
 RX-212 49W
 RX-216 54W

Finish

Black panel, rosewood trim

Dimensions (W×D×H)

RX-208
 564 × 687 × 206 mm (22-1/4" × 27" × 8-1/8")
 RX-212
 564 × 687 × 206 mm (22-1/4" × 27" × 8-1/8")
 RX-216
 684 × 687 × 206 mm (26-7/8" × 27" × 8-1/8")

Weight

RX-208 21kg (46.3 lbs)
 RX-212 22kg (48.5 lbs)
 RX-216 26kg (57.3 lbs)

Accessory

Fuse

*0dB is referenced to 0.775V RMS

Specifications are subject to change without notice.

Input & Output Specifications

INPUT SPECIFICATIONS

0dB is referenced to 0.775V RMS.

Input		Actual Load Impedance	For Use With Nominal	Sensitivity*	Input Level (Trim "0" to Trim "-30")		Connector
					Nominal	MAX. Before Clip	
CHANNEL IN	BAL-60	550 ohms	50 to 600 ohms	-80dB (0.08mV)	-60dB (0.78mV) to -30dB (25mV)	-40dB (7.8mV) to -10dB (250mV)	XLR-3-31 type**
	BAL-40	800 ohms		-60dB (0.78mV)	-40dB (7.8mV) to -10dB (250mV)	-20dB (78mV) to +10dB (2.5V)	
BAL-20	900 ohms	-40dB (7.8mV)		-20dB (78mV) to +10dB (2.5V)	0dB (775V) to +30dB (25V)		
	UN-BAL	25k ohms	10k ohms	-50dB (2.5mV)	-30dB (25mV) to 0dB (775mV)	-10dB (250mV) to +20dB (7.8V)	PHONE JACK
ACCESSORY (RCV)		10k ohms	10k ohms	-20dB (78mV)	-0dB (775mV)	20dB (7.8mV)	3P PHONE JACK***
STEREO IN	AUX PHONO	10k ohms	10k ohms	-40dB (7.8mV)	-20dB (78mV)	+10dB (2.5V)	RCA PIN JACK
		47k ohms	47k ohms	-70dB (0.25mV)	-50dB (2.5mV)	-20dB (78mV)	
AUXECHO IN		10k ohms	10k ohms	-40dB (7.8mV)	-20dB (78mV)	0dB (775mV)	PHONE JACK
SUB IN		10k ohms	10k ohms	-10dB (250mV)	+4dB (1.23mV)	+24dB (12.3mV)	PHONE JACK

OUTPUT SPECIFICATIONS

0dB is referenced to 0.775V RMS.

Output		Actual Source Impedance	For Use With Nominal	Output Level		Connector
				Nominal	MAX Before Clip	
LINE OUT	PGM L	100 ohms	600 ohms	+4dB (1.23V)	+20dB (7.8V)	XLR-3-32 type** and PHONE JACK
	PGMR FB1 FB2					
ECHO SEND	+4	90 ohms	600 ohms	+4dB (1.23V) -20dB (78mV)	+20dB (7.8V) -4dB (490mV)	PHONE JACK PHONE JACK
	-20	64 ohms				
REC OUT		1k ohms	10k ohms	-10dB (250mV)	+10dB (2.5V)	RCA PIN JACK
ACCESSORY (SEND)		1k ohms	10k ohms	0dB (775mV)	+20dB (7.8V)	3P PHONE JACK***
PHONES		18 ohms	8 ohms or higher	75mW/8 ohms, 0dB (775mV)	370mW/8 ohms, +7dB (1.7V)	STEREO PHONE JACK****

*Sensitivity is the level required to produce a nominal speaker output level.

**All XLR type connectors are floating, balanced and transformer-isolated.

***ACCESSORY jacks (3P PHONE JACK) are wired: Tip=Receive, Ring=Send and Sleeve =Common

****Stereo phone jack is wired: Tip=Left, Ring=Right and Sleeve=Common

Note:

As is described in the beginning of the operation manual, the XLR type connectors of the RX-208, RX-212 and RX-216 are wired as follows.

Pin No. 1 — Ground

Pin No. 2 — Cold (Low)

Pin No. 3 — Hot (High)

Specifications are subject to change without notice.

Caution:

The fuse rating for 120V AC operation is 2 amps., and 1 amp. for 220/240V AC operation. The fuse must always be replaced with same type and rating.

Characteristic Diagrams

Frequency Response

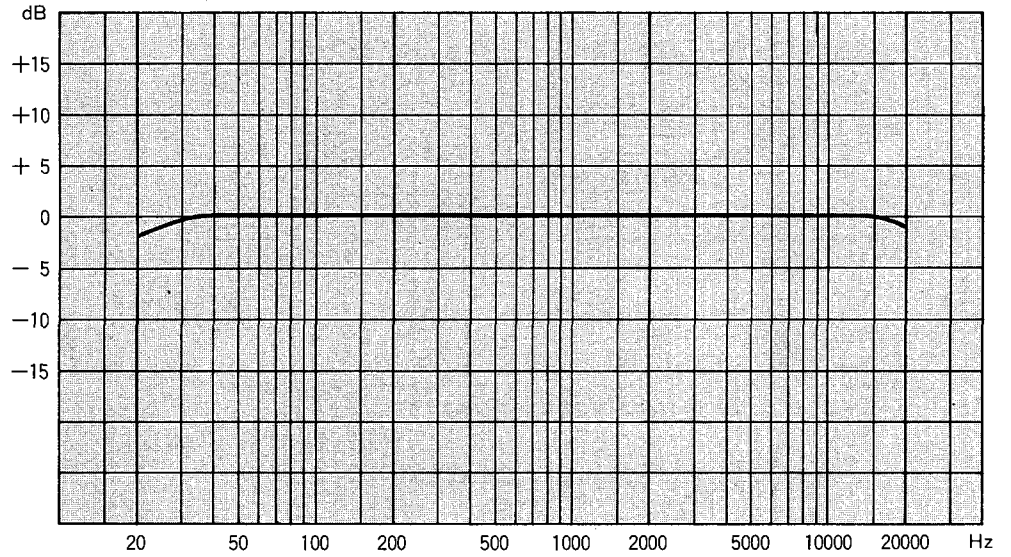

Input EQ Characteristics

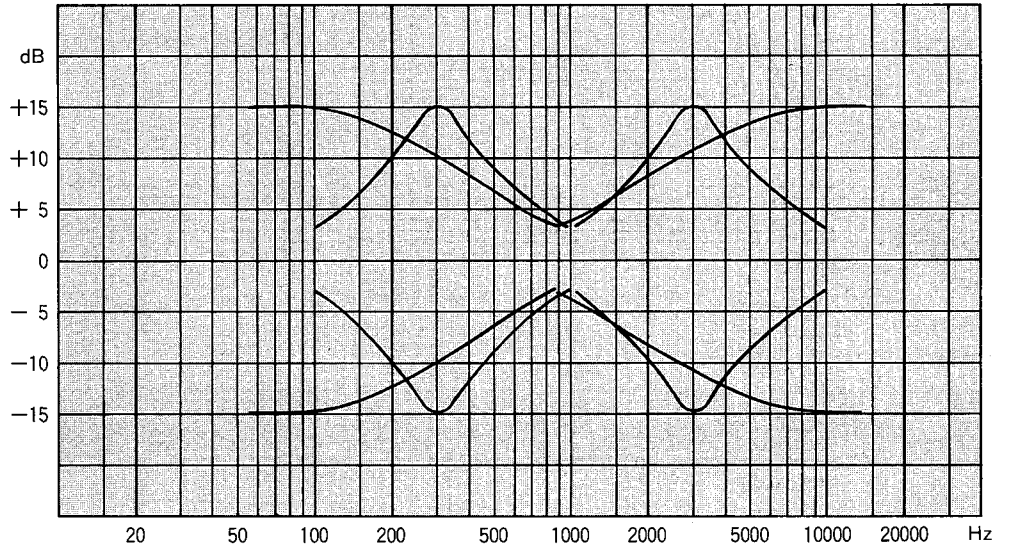

Graphic EQ Characteristics

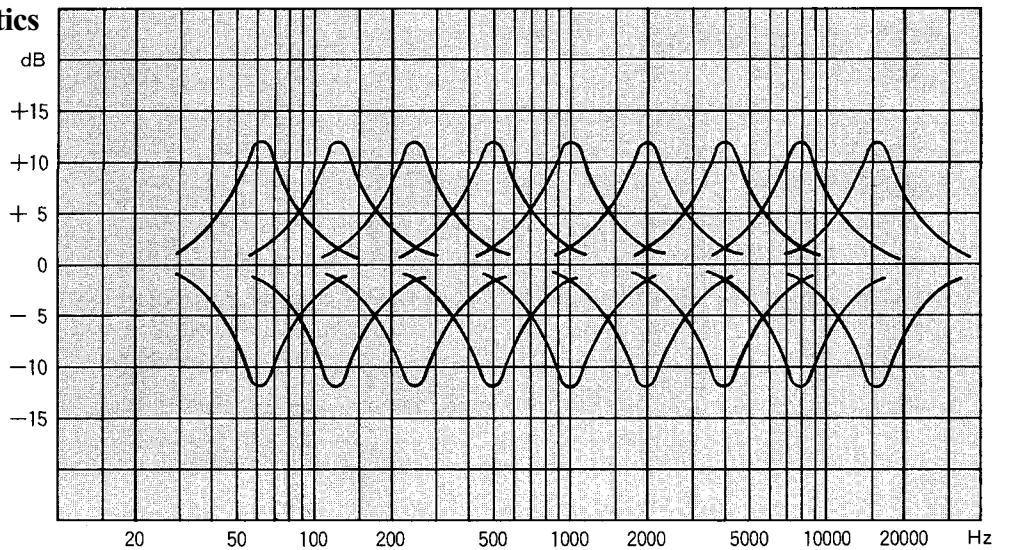

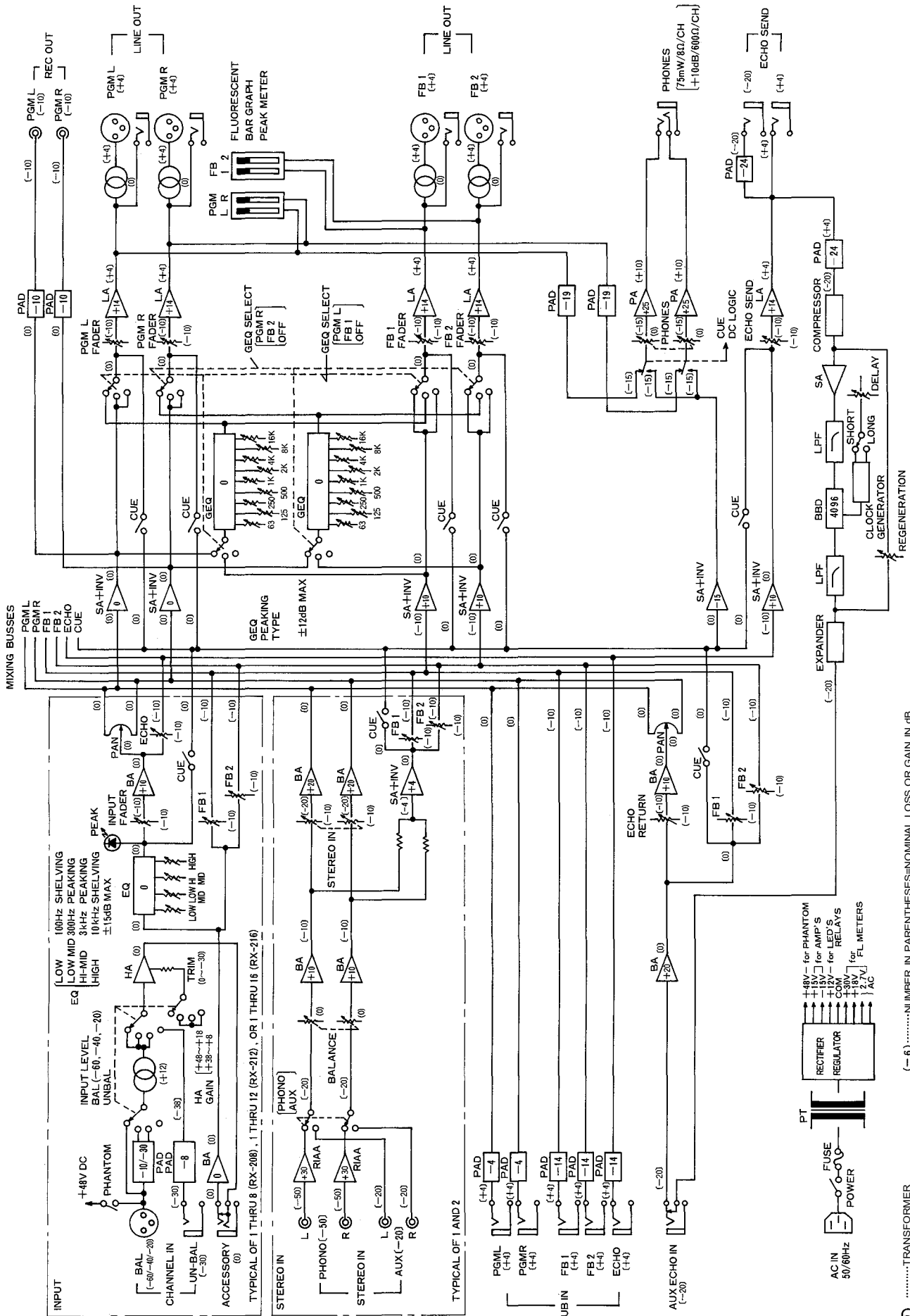

- ⊞TRANSFORMER
- ⊞AMPLIFIER
- ⊞SWITCH
- ⊞FADER OR LEVEL CONTROL
- (-6)NUMBER IN PARENTHESES=NOMINAL LOSS OR GAIN IN dB
- (+4)NUMBER IN SQUARE BRACKETS=NOMINAL SIGNAL LEVEL
- +10NUMBER IN TRIANGLE=GAIN OF AMPLIFIER IN dB
- 10NUMBER IN RECTANGLE=LOSS OF ATTENUATOR IN dB

Level Diagram

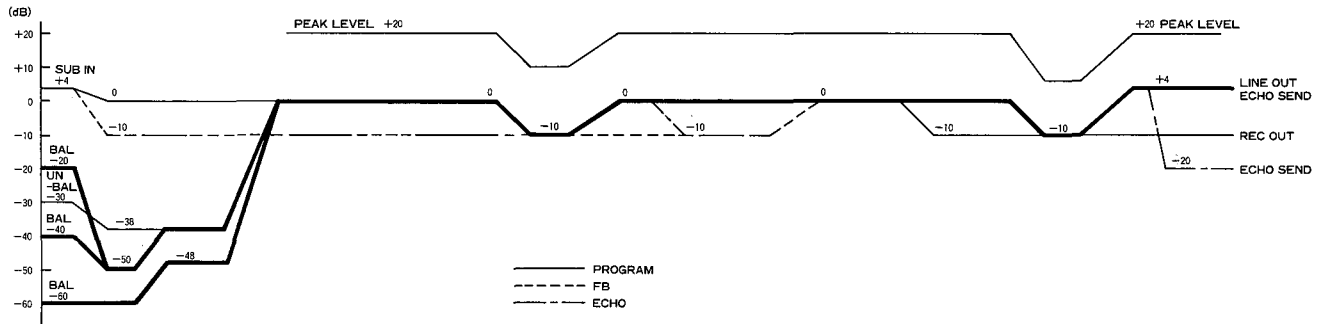
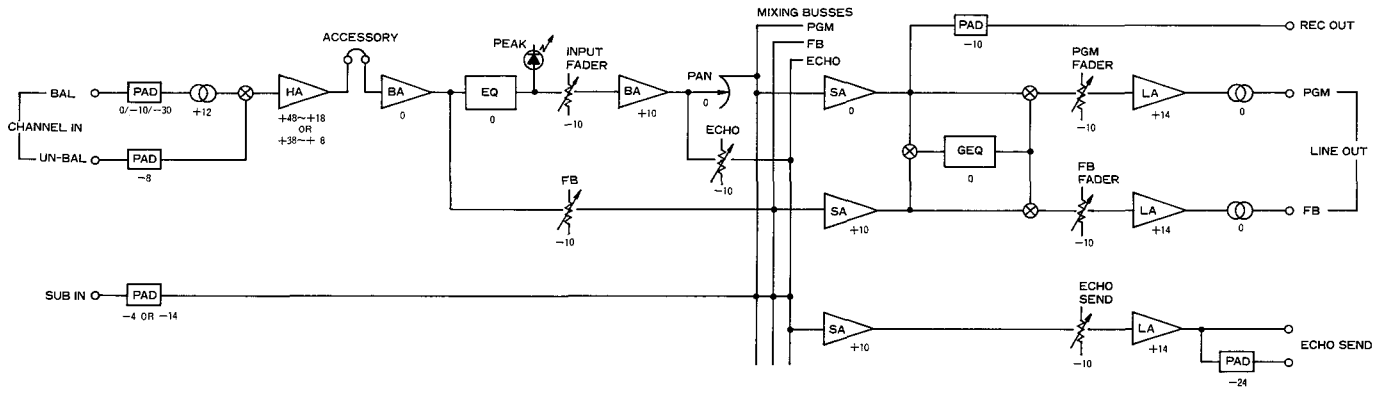

Dimensional Diagrams

RX-208, RX-212

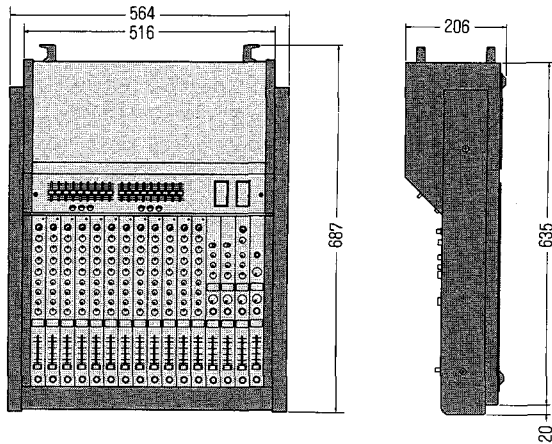

RX-216

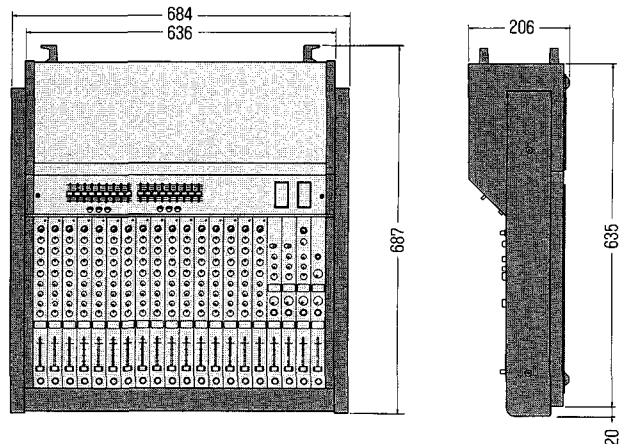

The above dimensional diagram is for the RX-212.
Overall dimensional of the RX-208 is the same as the RX-212.



TOA ELECTRIC CO., LTD.
KOBE, JAPAN